

E-Bike Katalog



Betrieb	02
Fantic philosophy	04
E-Bikes overview	06
E-MTB Light Rampage XC/DC	09
E-MTB Trail	17
E-MTB All Mountain	31
E-MTB Enduro	37
E-MTB Downhill	43
E-MTB Hardtail	47
Issimo und Trekking	51
Technische Daten	63



Fantic ist
eine Marke
mit über 50
Jahren
Geschichte.

Fantic E-Bikes sind ausschließlich als Elektrofahrräder konzipiert und hergestellt. **Exklusive Projekte**, um die besten Leistungen erzielen zu können. Der Akku ist so positioniert, dass die Demontage erleichtert und vor Stößen und Schmutz geschützt ist.

Fantic philosophy

01

Leistung

Ziel ist die Entwicklung von **E-Bikes mit der besten Akku- und Elektromotorleistung**. Neue integrierte Batterie mit 720 Wh 40 Zellen. Eine lange Lebensdauer auch bei hohen Belastungen. Neues Steuerungssystem zur **Optimierung des Batterieverbrauchs**.

02

Handling

Ein **Fantic E-Bike war noch nie so einfach** auf den härtesten Singletrails und Enduro-Strecken zu fahren. Positionierung von Motor, Akku und Antriebsstrang in der Mitte des Fahrrads. Verbessert die Gewichtsverteilung und reduziert die Yaw Gierträgheit. Der Akku ist kompakt und oberhalb des Motors angeordnet, um den Schwerpunkt des **E-Bikes** zu optimieren. Dies erlaubt eine geringe Trägheit und den Schwerpunkt zu senken, um schnelle und einfache Richtungswechsel vorzunehmen. **Advanced Hydroformed-Rahmen mit ausgewählter Spitzentechnologie von Fantic**, um eine steifere Rahmenstruktur für Präzision und Reaktionsfähigkeit auf höchstem Niveau zu gewährleisten.



Exklusivität

Fantic E-Bikes sind ausschließlich als Elektrofahrräder konzipiert und hergestellt. **Exklusive Projekte**, um die **besten Leistungen** erzielen zu können. Der Akku ist so positioniert, dass die Demontage erleichtert und vor Stößen und Schmutz geschützt ist."

03

Kontrolle

Das Gestänge der Hinterradaufhängung ist mit dem **FPS (Fantic Progression System)** ausgestattet, das im Hinblick auf die Bodenhaftung auf jedem Untergrund hohe Leistungen gewährleistet. Unsere F&E-Abteilung hat in Zusammenarbeit mit **Acerbis** ein Hinterachs-Federbein aus **ingespritztem Verbundwerkstoff** entworfen und entwickelt. Diese neue Technologie bietet bessere Leistungen und eine kürzere Reaktionszeit des Federbeins auf Bodenbelastungen als andere Materialien und sorgt für ein neues Design, das ins Auge springt. Diese technische Innovation wird in den Bereichen Trail Alu, All-Mountain, Enduro und DH zu finden sein. Die von uns verwendeten Motoren werden von unseren Ingenieuren so ausgewählt, dass sie bereits bei niedrigen Trittfrequenzen (zwischen 60-90 Pedaltritten pro Minute) ein **optimales Drehmoment liefern**, bis hin zu einem maximalen Drehmoment von 120 Nm (*). Die Kombination der 29/27,5-Zoll-Räder, die dank der Erfahrung von **Fantic** in der Motorradindustrie entwickelt wurde, gewährleistet eine unvergleichliche Kontrolle des Fahrzeugs. (*) Für das Modell Issimo 45.



Kontrolle



Handling



Exklusivität



Leistung

*Das Fahrrad auf dem Foto ist das Modell **Rampage 1.2 Factory**.



**E-MTB
Light
Rampage
XC/DC
S. 09**



Rampage 1.2 Factory Rampage 1.2 Race Rampage 1.4 Factory



Rampage 1.4 Race Rampage 1.4 Sport

**E-MTB
Trail
S. 17**



XTF 1.6 Carbon Factory XTF 1.6 Carbon Race XTF 1.6 Carbon Sport



XTF 1.5 Carbon XTF 1.5 Race-Y XTF 1.5 Sport-Y XTF 1.5 All Track



XTF 1.5 Y XTF 1.5 Race XTF 1.5 Sport XTF 1.5

**E-MTB
All
Mountain
S. 31**



XMF 1.7 Carbon Race XMF 1.7 Carbon Sport XMF 1.7

**E-MTB
Enduro
S. 37**



XEF 1.9 Factory XEF 1.9 Race XEF 1.8 Sport

**E-MTB
Downhill
S. 43**



XXF 2.0 Factory XXF 2.0 Race

**E-MTB
Hard
Tail
S. 47**



Fat Sport Integra XF2

**Issimo
und
Trekking
S. 51**



Issimo Fun Issimo Urban Issimo 45



Seven Days Living Seven Days Living Easy Living Living Easy



Living City

06

07



E-MTB Light Rampage XC/DC



Auf Cross Country **Strecken über längere Distanzen und mit hohen Geschwindigkeiten** den Adrenalinspiegel in die Höhe treiben - der Name ist Programm: **Rampage** - das erste E-MTB von **Fantic** im Segment der Light-E-MTBs.

Das innovative **Rampage**, entwickelt von **Fantic's** R&D-Abteilung mit dem Fokus auf Leichtigkeit, besteht durch einen Vollcarbonrahmen, und wiegt in der High-End-Version nur 15,5 kg. Der nahtlos integrierte Akku kann leicht übersehen werden.



Rampage 1.2 Factory

Farbvariante:
red



Colour options:
black



Rampage 1.2 Race



App



App



10

Technische Daten

Farbe: **black**

Full-Carbon, sizes: S-M-L-XL	Sram XX Eagle Transmission, 12V, 10-52
TQ HPR-50, Torque/Coppia: 50 Nm	Magura MT8 SL 2 Piston disc brake
TQ integrated, Lithium Ion, 360Wh	Mavic Crossmax SL Ultimate 29"
RockShox SID Ultimate 2P 120mm Remote lock	Pirelli SCORPION ProWall XC-RC
RockShox SIDLuxe 2P Ultimate Remote lock	Selle Italia SLR Boost Superflow
Fantic Racing Integrated Flat 17°, 780mm	Crankbrothers Highline 11 Ø30.9 - carbon



11

Technische Daten

Farbe: **red**

Full-Carbon, sizes: S-M-L-XL	Sram GX, 12V, 10-52
TQ HPR-50, Torque/Coppia: 50 Nm	Magura MT8 PRO 2 Piston disc brake
TQ integrated, Lithium Ion, 360Wh	Mavic Crossmax SL S 29"
RockShox SID 2P 120mm Remote lock	Pirelli SCORPION ProWall XC-RC
RockShox SIDLuxe 2P Remote lock	Selle Italia Novus Boost X-Cross Superflow
Fantic Racing Integrated Flat 17°, 780mm	Crankbrothers Highline 3 Ø30.9

Rampage 1.4 Factory

Colour options:
black

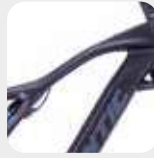

Farbvariante:
red

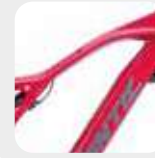

Rampage 1.4 Race



App















App

12



Farbe: **red**

Technische Daten

-  Full-Carbon, sizes: S-M-L-XL
-  Sram GX, 12V, 10-52
-  TQ HPR-50, Torque/Coppia: 50 Nm
-  Magura MT8 PRO 2 Piston disc brake
-  TQ integrated, Lithium Ion, 360Wh
-  Mavic Crossmax SL S 29"
-  Suntour AXON34 LO-RC PCS Factory
-  Vittoria SYERRA - 29"x 2.4
-  Suntour EDGE PLUS 2CR
-  Selle Italia Novus Boost X-Cross Superflow
-  Fantic Racing Integrated Flat 17°, 780mm
-  RockShox Rverb AXS













Kontrolle, Handling, Exklusivität, Leistung.

13



Farbe: **black**

Technische Daten

-  Full-Carbon, sizes: S-M-L-XL
-  Sram SX, 12V, 11-50
-  TQ HPR-50, Torque/Coppia: 50 Nm
-  Sram LEVEL 2 Piston disc brake
-  TQ integrated, Lithium Ion, 360Wh
-  GBC Radiale 29"
-  Suntour RAIDON34 LOR
-  Vittoria SYERRA - 29"x 2.4
-  Suntour EDGE PLUS 2CR
-  Selle Italia Model-X Superflow
-  GBC Ø31,8 FLAT
-  Crankbrothers Highline 3 Ø30.9

Rampage 1.4 Sport

Farbvariante:
red

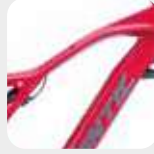



App



Technische Daten

Farbe: **black**

	Full-Carbon, sizes: S-M-L-XL		Sram SX, 12V, 11-50
	TQ HPR-50, Torque/Coppia: 50 Nm		Sram LEVEL 2 Piston disc brake
	TQ integrated, Lithium Ion, 360Wh		GBC Radiale 29"
	Suntour RAIDON34 LOR		Vittoria SYERRA - 29"x 2.4
	Suntour EDGE PLUS 2CR		Selle Italia Model-X Superflow
	GBC Ø31,8 FLAT		RST ELEV8 A2 Ø30.9

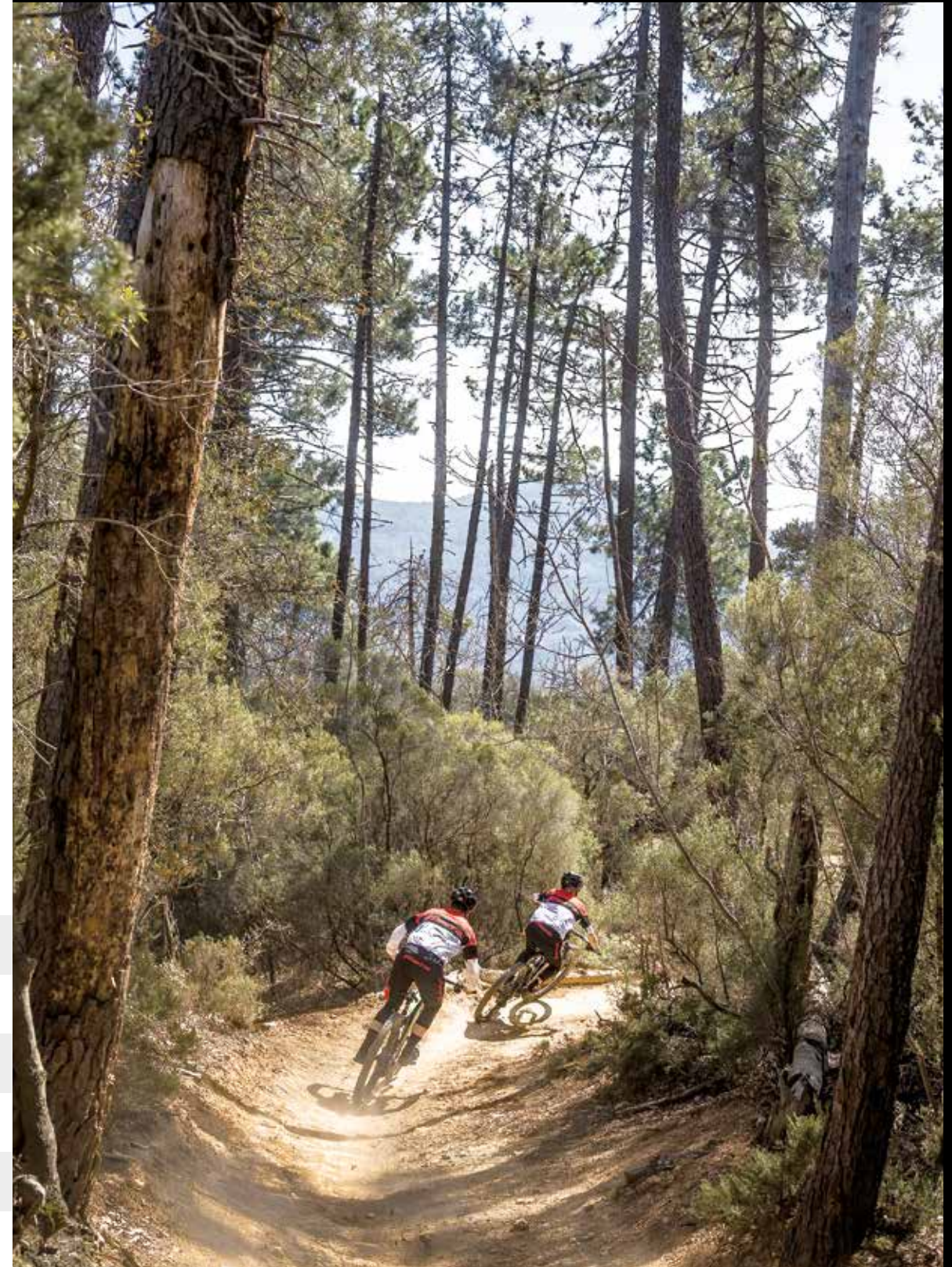



E-MTB Trail



Die Baureihe **Trail** besteht aus 11 Modellen mit Carbon- und Aluminiumrahmen, alle vollgefedert mit einer Vorderradfederung von 150 oder 160 mm

Sie sind mit Motoren von **Brose und Yamaha** für maximale Leistung ausgestattet.

Die Rahmen werden alle von **Fantic selbstentworfen und entwickelt**, wobei wir uns streng an unsere 4 Designprinzipien halten (Handling, Control, Mileage, Exclusivity), um leistungsstarke, sichere und attraktive Fahrräder herzustellen.

Das Spitzenmodell der Linie ist das **XTF 1.6 Carbon Factory**, das mit seinen 19,9 kg das leichteste und leistungsstärkste E-MTB **Trail** auf dem Markt ist.



XTF 1.6 Carbon Factory

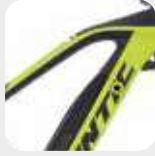

App

Farbvariante:
limeFarbvariante:
cool gray

FANTIC

XTF 1.6 Carbon Race



App



18

Technische Daten

Farbe: cool gray

Carbon, sizes: S - M - L - XL	Sram X-Glide Rainbow, 12V, 10-52
Brose S-Mag 36, Torque/Coppia: 90 Nm	Magura MT Trail Sport 4 Piston disc brake
Fantic, Lithium Ion, 36 Volt, 720Wh	FSA KFX Carbon 29"
RockShox Lyrik Ultimate 160mm	Pirelli Scorpion ProWall Trail
RockShox Deluxe Ultimate	Selle Italia SLR Boost Superflow
FANTIC RACING INTEGRATED FLAT-17°, 780mm	Rockshox Reverb AXS Ø 30.9



19

Technische Daten

Farbe: lime

Carbon, sizes: S - M - L - XL	SunRace SilverRed, 12V, 11-51
Brose S-Mag 36, Torque/Coppia: 90 Nm	Sram G2 RS 4 Piston disc brake
Fantic, Lithium Ion, 36 Volt, 720Wh	FSA i29 Carbon 29"
RockShox Lirik Select 160mm	Pirelli Scorpion ProWall Trail
RockShox Deluxe Select+	Selle Italia Novus Boost X-Cross Superflow
FANTIC RACING Carbon Ø31,8 Rise 25, 760mm	Switch SW Ø 30.9

XTF 1.6 Carbon Sport



App

 Farbvariante:
cool gray

 Farbvariante:
cool gray

FANTIC

XTF 1.5 Carbon



App



Technische Daten

Farbe: lime

Carbon, sizes: S - M - L - XL	Sram SX, 12V, 11-50
Brose S-Mag 36, Torque/Coppia: 90 Nm	Sram G2 RS 4 Piston disc brake
Fantic, Lithium Ion, 36 Volt, 720Wh	Rodi READY27 - 29"
RockShox Lyrik Select 160mm	Pirelli Scorpion ProWall Trail
RockShox Deluxe Select+	Selle Italia X Bow Superflow
FSA 760mm- Ø31,8 Rise 15mm - Sweep 6°	Switch SW Ø 30.9

20
24

Kontrolle, Handling, Exklusivität, Leistung.



Technische Daten

Farbe: lime

Carbon, sizes: S - M - L - XL	Sram SX, 12V, 11-51
Brose S-Mag 36, Torque/Coppia: 90 Nm	Sram GUIDE T 4 Piston disc brake
Fantic, Lithium Ion, 36 Volt, 720Wh	Rodi READY27- 29"
RockShox 35 Gold RL 150mm	Pirelli Scorpion ProWall Trail
RockShox Deluxe Select+	Selle Italia Model-X Comfort Superflow 145
FSA 760mm- Ø31,8 Rise 15mm - Sweep 6°	Switch SW Ø 30.9

(*) FANTIC MOTOR behält sich das Recht vor, technische Eigenschaften ohne vorherige Ankündigung zu ändern. Änderungen der Produkte sind vorbehalten.

XTF 1.5 Race-Y

Farbvariante:
green



Farbvariante:
grey



XTF 1.5 Sport-Y



App



App















Technische Daten

Das Federbein aus "gespritztem Verbundwerkstoff" Farbe: grey

	Aluminum, sizes: S - M - L		Sram SX, 12V, 11-50
	Yamaha PW X3, Torque/Coppia: 85 Nm		Sram Guide T 4 Piston disc brake
	Fantic, Lithium Ion, 36 Volt, 630Wh		Rodi TRYP30 - 29"
	RockShox 35 Gold RL - 29" 150mm		Pirelli Scorpion ProWall Trail
	RockShox Deluxe Select+		Selle Italia Model-X Comfort Superflow 145
	FSA 760mm- Ø31,8 Rise 15mm - Sweep 6°		Switch SW Ø 30,9, S - 80mm / M - 100mm / L - 125mm

Technische Daten

Das Federbein aus "gespritztem Verbundwerkstoff" Farbe: green

	Aluminum, sizes: S - M - L		Sram SX, 12V, 11-50
	Yamaha PW X3, Torque/Coppia: 85 Nm		Sram Guide T 4 Piston disc brake
	Fantic, Lithium Ion, 36 Volt, 630Wh		Rodi TRYP30 - 29"
	RockShox 35 Gold RL 150mm		Pirelli Scorpion ProWall Trail
	RockShox Deluxe Select+		Selle Italia Model-X Comfort Superflow 145
	Promax-760mm Rise 18mm-Ø31,8		Switch SW Ø30.9

XTF 1.5 All Track

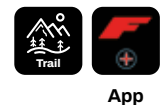

XTF 1.5 Y

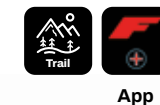













24



Technische Daten

Das Federbein aus "gespritztem Verbundwerkstoff" Farbe: grey

-  Aluminum, sizes: S - M - L
-  Sram SX, 12V, 11-50
-  Yamaha PW X3, Torque/Coppia: 85 Nm
-  Sram Level 2 Piston disc brake
-  Fantic, Lithium Ion, 36 Volt, 630Wh
-  Rodi TRYP30 - 29"
-  RockShox Recon Silver RL 150mm
-  Pirelli Scorpion ProWall Trail
-  RockShox Deluxe Select
-  Selle Italia MODEL-X Comfort Superflow 145
-  Promax-760mm Rise 18mm-ø31,8
-  Switch SW Ø30.9

20
24













Kontrolle, Handling, Exklusivität, Leistung.

25



Technische Daten

Farbe: grey

-  Aluminum, Sizes: S - M - L
-  Sram SX, 12V, 11-50
-  Yamaha PW S2, Torque/Coppia: 75 Nm
-  Sram LEVEL 2 Piston disc brake
-  Fantic, Lithium Ion, 36 Volt, 630Wh
-  Rodi TRYP30 - 29"
-  Suntour Zeron 35 150mm
-  Pirelli SCORPION ProWall Trail
-  Suntour Edge-R Plus
-  Selle Italia MODEL-X Comfort Superflow 145
-  Promax-760mm-Rise 18mm-ø31,8
-  Promax Ø30.9

(*) FANTIC MOTOR behält sich das Recht vor, technische Eigenschaften ohne vorherige Ankündigung zu ändern. Änderungen der Produkte sind vorbehalten.

XTF 1.5 Race

Farbvariante:
silver



Farbvariante:
yellow

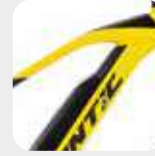

XTF 1.5 Sport



App



App



26



27













Technische Daten

Farbe: **yellow**

 Aluminum, sizes: S - M - L	 Sram SX, 12V, 11-50
 Brose S-Alu, Torque/Coppia: 90 Nm	 Sram Guide T 4 Piston disc brake
 Fantic, Lithium Ion, 36 Volt, 630Wh	 Rodi TRYP30
 RockShox 35 Gold RL 150mm	 Pirelli Scorpion Trail
 RockShox Deluxe Select+	 Selle Italia Model-X Comfort Superflow 145
 FSA Ø31,8 - Rise15mm - Sweep 6°	 Switch SW Ø 30,9, S - 80mm / M - 100mm / L - 125mm

Technische Daten

Farbe: **silver**

 Aluminum, sizes: S - M - L	 Sram SX, 12V, 11-50
 Brose S-Alu, Torque/Coppia: 90 Nm	 Sram Guide T 4 Piston disc brake
 Fantic, Lithium Ion, 36 Volt, 630Wh	 Rodi TRYP30
 RockShox 35 Gold RL 150mm	 Pirelli Scorpion Trail
 RockShox Deluxe Select+	 Selle Italia Model-X Comfort Superflow 145
 Promax ø31,8 760mm Rise 20mm	 Promax teles. SP -2038 Ø 30.9, S 80mm / M-L 100mm

XTF 1.5

Farbvariante:
silver















App



Technische Daten

Farbe: **yellow**

	Aluminum, sizes: S - M - L		Sram SX Eagle
	Brose S-Alu, Torque/Coppia: 90 Nm		Sram Level 2 Piston disc brake
	Fantic, Lithium Ion, 36 Volt, 630Wh		Rodi TRYP30
	RockShox Recon Silver RL 150mm		Pirelli Scorpion ProWall
	RockShox Deluxe Select		Selle Italia Model-X Comfort Superflow 145
	Promax ø31,8 760mm Rise 20mm		Promax teles. SP -2038 Ø 30.9, S 80mm / M-L 100mm





E-MTB All Mountain



E-MTB All Mountain von **Fantic**,
das Stichwort ist **Vielseitigkeit!**

Die All Mountain-Reihe wurde entwickelt, **um eine hervorragende Balance zwischen Downhill-Performance und Uphill-Pedalen zu bieten.** Sie besteht aus 2 Modellen, einem mit Carbonrahmen und einem aus Aluminium, beide vollgefedert für maximale Stoßdämpfung mit 170 mm Federweg.

Fantic hat **All Mountain** für alle entwickelt, die ein leistungsstarkes und vielseitiges Fahrrad suchen, das für alle Arten von Strecken und Wegen geeignet ist, von solchen mit wenig Höhenunterschied bis hin zu anspruchsvollen Abfahrten.



XMF 1.7 Carbon Race



App



Technische Daten

Farbe: **carbon black**

Carbon, sizes: S - M - L	Sram SX, 12V, 11-50
Brose S-Mag 36, Torque/Coppia: 90 Nm	Magura MT7 4 Piston disc brake
Fantic, Lithium Ion, 36 Volt, 720Wh	Fulcrum E-Fire 500 29"-27.5"
RockShox Zeb Select 170mm	Vittoria E-Martello
RockShox SuperDeluxe Select+	Selle Italia Novus Boost X-Cross Superflow
Fantic Racing - 800mm Ø35 - Rise 20mm	Crankbrothers Highline7 Ø 30.9

20
24**Kontrolle, Handling, Exklusivität, Leistung.**

XMF 1.7 Carbon Sport



App



Technische Daten

Farbe: **carbon black**

Carbon, sizes: S - M - L	Sram SX, 12V, 11-50
Brose S-Mag 36, Torque/Coppia: 90 Nm	Sram Code R 4 Piston disc brake
Fantic, Lithium Ion, 36 Volt, 720Wh	Fulcrum E-Fire 700 29"-27.5"
Suntour Durolux 38	Vittoria E-Martello
RockShox SuperDeluxe Select+	Selle Italia X Bow Superflow
FSA Grid - 800mm Ø35 - Rise 15mm	Switch SW Ø 30.9

(*) FANTIC MOTOR behält sich das Recht vor, technische Eigenschaften ohne vorherige Ankündigung zu ändern. Änderungen der Produkte sind vorbehalten.

XMF 1.7

Farbvariante:
military green

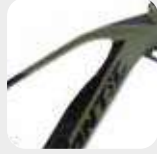

App



Technische Daten

Farbe: **white**

	Aluminum, sizes: S - M - L		Sram SX, 12V, 11-50
	Brose S-Mag 36, Torque/Coppia: 90 Nm		Sram Guide T 4 Piston disc brake
	Fantic, Lithium Ion, 36 Volt, 720Wh		Fulcrum E-Fire 700 29"-27.5"
	RockShox Domain R 170mm		Vittoria E-Martello
	RockShox Deluxe Select+		Selle Italia Model X Comfort Superflow 145
	FSA Comet-800mm Ø35 - Rise 15mm		Switch SW Ø 30.9 S-M, L





E-MTB Enduro



Die **Enduro**-Reihe wurde für natürliche Abfahrten, New School Trails, Bikeparks und aggressive Pisten entwickelt und besteht aus Modellen: **Sport, Race und Factory**, wobei sich letzteres durch die **Carbon-Sitzstreben** auszeichnet. Beide sind voll gefedert für maximale Stoßdämpfung mit 180 und 190 mm Federweg.

Fantic hat das **Enduro** für all diejenigen entwickelt, die ein extrem leistungsfähiges Fahrrad suchen, das sowohl auf steilen als auch auf holprigen Strecken wendig und zuverlässig ist, gleichzeitig aber auch fahrbar und dank des 720-Wh-Akkus mit langer Laufzeit sehr gut zu fahren ist.



XEF 1.9 Factory

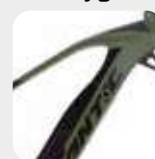

App

Farbvariante:
whiteFarbvariante:
military green

FANTIC

XEF 1.9 Race



App

38

Farbe: **military green**

Technische Daten

	Aluminum, sizes: S - M - L		SunRace SilverRed, 12V, 11-51
	Brose S-Mag 36, Torque/Coppia: 90 Nm		Braking IN.CA.S disc brake
	Fantic, Lithium Ion, 36 Volt, 720Wh		Mavic E-Deemax 29"- 27.5"
	RockShox Zeb Ultimate 190mm		Vittoria E-Mazza Vittoria E-Martello
	Ohlins TTX 22M		Selle Italia Novus Boost X Cross Superflow
	Fantic Racing-800mm Ø35 - Rise 20mm -Sand		Crankbrothers HIGHLIGHT7 Ø 30.9

20
24

Kontrolle, Handling, Exklusivität, Leistung.

39

Farbe: **white**

Technische Daten

	Aluminum, sizes: S - M - L		Sram SX, 12V, 11-50
	Brose S-Mag 36, Torque/Coppia: 90 Nm		Magura MT7 4 Piston disc brake
	Fantic, Lithium Ion, 36 Volt, 720Wh		Mavic E-Deemax 29"- 27.5"
	RockShox Zeb Select 190mm		Vittoria E-Mazza Vittoria E-Martello
	RockShox SuperDeluxe Coil Select+		Selle Italia Model-X Bow Superflow
	FSA Gradient - 800mm Ø35 - Rise 15mm		Crankbrothers HIGHLIGHT7 Ø 30.9 S-M, L

(*) FANTIC MOTOR behält sich das Recht vor, technische Eigenschaften ohne vorherige Ankündigung zu ändern.
Änderungen der Produkte sind vorbehalten.

XEF 1.8 Sport

Farbvariante:
white



App



Technische Daten

Farbe: **military green**

	Aluminum, sizes: S - M - L		Sram SX, 12V, 11-50
	Brose S-Mag 36, Torque/Coppia: 90 Nm		Sram Code R 4 Piston disc brake
	Fantic, Lithium Ion, 36 Volt, 720Wh		Mavic E-Deemax 29"- 27.5"
	RockShox Domain R 180mm		Vittoria E-Mazza Vittoria E-Martello
	RockShox SuperDeluxe Coil Select+		Selle Italia Model-X Comfort Superflow 145
	FSA Comet - 800mm Ø35 - Rise 25mm		Switch SW Ø 30.9





E-MTB Downhill



**E-MTB Downhill,
schnell wie der Wind!**

Entwickelt für aggressive Abfahrten und besonders steile Strecken, besteht die gesamte **Downhill**-Reihe aus 2 Modellen, Race und Factory, wobei sich das zweite durch die **Carbon-Sitzstreben** auszeichnet. Beide sind für maximale Stoßdämpfung voll gefedert und haben einen Federweg von 200 mm.



XXF 2.0 Factory

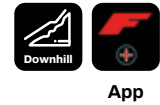

Farbvariante:
white



Farbvariante:
military green

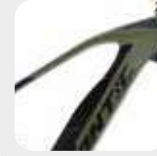

XXF 2.0 Race

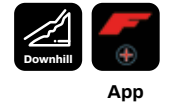

44



Farbe: **military green**

Technische Daten

	Aluminum, sizes: S - M - L		SunRace SilverRed, 12V, 11-51
	Brose S-Mag 36, Torque/Coppia: 90 Nm		Braking IN.CA.S disc brake
	Fantic, Lithium Ion, 36 Volt, 720Wh		Mavic E-Deemax 29"- 27.5"
	Ohlins DH 38 200mm		Vittoria E-Mazza Vittoria E-Martello
	Ohlins TTX 22M		Selle Italia Novus Boost X Cross Superflow
	Fantic Racing - 800mm Ø35 - Rise 30mm - Sand		Crankbrothers HIGHLIGHT7 Ø 30.9

45



Farbe: **white**

Technische Daten

	Aluminum, sizes: S - M - L		Sram SX Eagle 12V, 11-50
	Brose S-Mag, Torque/Coppia: 90 Nm		Magura MT7 4 Piston disc brake
	Fantic, Lithium Ion, 36 Volt, 720Wh		Mavic E-Deemax 29"- 27.5"
	RockShox Boxxer Select, 200mm		Vittoria E-Mazza Vittoria E-Martello
	RockShox SuperDeluxe Coil Select+		Selle Italia Model-X Comfort Superflow
	FSA Gradient - 800mm Ø35 - Rise 25mm		Switch SW Ø 30.9



E-MTB Hard Tail



MTB Hard Tail,
die praktische und technische Wahl!

Die **Hard Tail**-Reihe wurde für hügelige oder bewaldete Wege, Schotterpisten oder unbefestigte Straßen entwickelt und besteht aus zwei Modellen, dem **Integra** und dem **Fat**, die beide vorne gefedert sind und nur vorne 120 mm Federweg haben.



Fat Sport









App



48

Technische Daten

Farbe: **sage green**

	Aluminium, sizes: S - M - L		Sram Level, 2P, Hydraulic Disc Brake, 200mm disc
	Brose T-Alu, Torque/Coppia: 70 Nm		Gipiemme 26"
	Fantic, Lithium Ion, 36 Volt, 630Wh		Schwalbe Jumbo-Jim
	RockShox Bluto, 120mm		Selle Italia Model X Comfort superflow
	Sram SX Eagle 12V, 11-50		FSA Ø30.9
	FSA Ø31,8 - 760m - Rise 15mm		

20
24

Kontrolle, Handling, Exklusivität, Leistung.

Integra XF2













App



49

Technische Daten

Farbe: **red**

	Aluminium, sizes: S - M - L		Sram Level, 2P, Hydraulic Disc Brake, 200mm disc
	Brose T-Alu, Torque/Coppia: 70 Nm		Gipiemme, tubeless ready
	Fantic, Lithium Ion, 36 Volt, 630Wh		Vittoria Barzo
	RockShox Recon Silver RL, 120mm		Selle Italia Model X Comfort superflow
	Sram SX, 12V, 11-50		FSA
	FSA Ø31,8 - 760m - Rise 15mm		

(*) FANTIC MOTOR behält sich das Recht vor, technische Eigenschaften ohne vorherige Ankündigung zu ändern. Änderungen der Produkte sind vorbehalten.



ISSIMO



Issimo 25 und Issimo 45 sind die neuesten Modelle der **Issimo**-Familie, die das Konzept der **nachhaltigen Mobilität** revolutioniert hat und das Fahren einfacher und sicherer macht. Issimo steht für **Sicherheit und Stabilität** auf jedem Terrain dank seiner Räder mit Fat 20x4"-Reifen und dem niedrigen Schwerpunkt und ist sowohl in der Urban- als auch in der Fun-Ausführung erhältlich.

Issimo Connect ist die Ausführung mit integriertem Bluetooth-GPS-Modul, das eine Verbindung mit der **Issimo-App** ermöglicht.

Trekking



Jeden Tag mit dem Fahrrad unterwegs sein, in der Stadt und im Freien, ohne dabei Kompromisse bei Sicherheit, Qualität und Komfort einzugehen. Darum haben wir die Welt von **Living** geschaffen, 5 Modelle **für den täglichen Einsatz, für jedermann.**



Issimo Fun

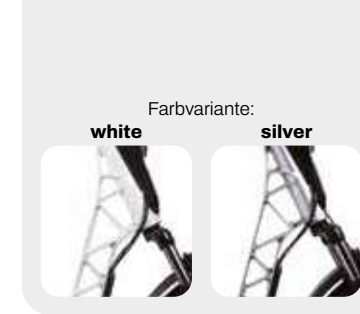

Issimo Urban











* App verfügbar in der Version **Issimo Urban Connect.**

52



Farbe: **black**

Technische Daten

-  Aluminum frame, Unix Design, One Size
-  16Th Chain rings
-  Bafang M500, Torque/Coppia: 95 Nm
-  Radius BH-M960
-  Fantic, Lithium Ion, 36 Volt, 630Wh
-  Gipiemme 20" Fat
-  Zoom 80mm
-  Vee-Tire Co - 20"X4" Mission Command

53



Farbe: **black**

Technische Daten

-  Aluminum frame, Unix Design, One Size
-  16Th Chain rings
-  Bafang M500, Torque/Coppia: 95 Nm
-  Radius BH-M960
-  Fantic, Lithium Ion, 36 Volt, 630Wh
-  Gipiemme 20" Fat
-  Zoom 80mm
-  Vee-Tire Co - 20"X4" Speedster

Issimo 45



Farbvariante:







white

silver



Technische Daten

Farbe: **black**

	Aluminum, Unix Design, One Size		Radius BH-M870-E with cut-off
	Bafang M600, Max power: 500 Watt, Torque/Coppia: 120 Nm		Gipiemme 20" Fat
	Fantic, Lithium Ion, 43 Volt, 600Wh		Vee-Tire Co - 20"X4" Speedster
	Zoom 80mm		

Issimo Zubehör

10 farbige Abdeckung



Seven Days Living



App



56

Technische Daten

Farbe: **black**

Aluminium, sizes: S - M - L	Sram Level steel hydraulic 2P, 180mm disc
Brose T-Alu, Torque/Coppia: 70Nm	GBC, Aluminium, 28"
Fantic, Lithium Ion, 36 Volt, 630Wh	Vittoria E-Randonneur
RockShox Recon 29, 100mm	Selle Italia ST 5 GF / Urban Gist
Sram SX, 12V, 11-50	GBC Over Back - 680mm, RISE 25mm

Seven Days Living Easy



App



57

Technische Daten

Farbe: **silver**

Aluminium, sizes: S/M - L/XL	Sram Level steel hydraulic 2P, 180mm disc
Brose T, Torque/Coppia: 70Nm	GBC, Aluminium, 28"
Fantic, Lithium Ion, 36 Volt, 630Wh	Vittoria E-Randonneur
RockShox Recon 29, 100mm	Selle Italia ST 5 GF / Urban Gist
Sram SX, 12V, 11-50	GBC Over Back - 680mm, RISE 25mm

Living

Living Easy



App



App



58

Technische Daten

Farbe: sand

	Aluminium, sizes: S - M - L		Promax Solve ST 925 hydraulic 2P, 180mm disc
	Yamaha PW S2, Torque/Coppia: 75Nm		GBC 29"
	Fantic, Lithium Ion, 36 Volt, 630Wh		Vittoria E-Randonneur
	Suntour XCR34, travel 100mm		Selle Italia S5 Superflow
	Sram SX, 12V, 11-50		GBC 700mm, Rise 20mm



59

Technische Daten

Farbe: blue

	Aluminium, sizes: S-M / L-XL		Promax Solve ST 925 hydraulic 2P, 180mm disc
	Yamaha PW S2, Torque/Coppia: 75Nm		GBC 29"
	Fantic, Lithium Ion, 36 Volt, 630Wh		Vittoria E-Randonneur
	Suntour XCR34, travel 100mm		Selle Italia Max S5 Superflow
	Sram SX, 12V, 11-50		GBC 700mm, Rise 20mm

Living City









App



Technische Daten

Farbe: **white**

	Aluminium, sizes: S - M - L		Promax Solve ST 925 hydraulic 2P, 180mm disc
	Yamaha PW S2, Torque/Coppia: 75Nm		GBC 29" (M-L) - 27.5" (S)
	Fantic, Lithium Ion, 36 Volt, 630Wh		Vittoria E-Randonneur
	RST Volant, travel 50mm		Selle Italia T3 Flow
	GBC 700mm, Rise 20mm		





Technische Daten

62

63



Rampage 1.2 Factory

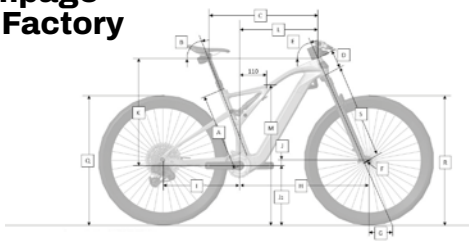

Maßnahmen	S	M	L	XL
A	410	440	470	500
B	75.00	75.00	500	500
C	585	607	633	658
D	95	105	120	130
E	64,50	65,00	65,00	65,50
F	51	51	51	51
G	121,5	118,0	118,0	114,3
H	732	748	775	794
I	437	437	437	437
J	23	23	23	23
J ₂	349	349	349	349
K	605	612	627	640
L	423.5	442.5	463.0	483.0
M	795	800	805	810
N	780	780	780	780
O	65* - 70*	65* - 70*	65* - 70*	65* - 70*
P	170	170	175	175
Q/R	29" 743mm	29" 743mm	29" 743mm	29" 743mm
S	562	562	562	562
Z	100	100	125	150

* 65 manubrio KFX SIC INTEGRATED
* 70 manubrio KFX FLAT

Motor	TQ HPR-50, Torque/Coppia: 50 Nm
Batterie	TQ integrated, Lithium Ion, 360Wh
Display	TFT top tube + remote
Rahmen	Full-Carbon, sizes: S-M-L-XL
Gabel	RockShox SID Ultimate 2P 120mm Remote lock
Dämpfer	RockShox SIDLuxe 2P Ultimate Remote lock
Kettenblätter	Sram Eagle Transmission 34t
Fahrrad kurbel	FSA Carbon
Schaltwerk	Sram XX SL Eagle Transmission
Schalthebel	Sram AXS
Schaltkassette	Sram XX Eagle Transmission, 12V, 10-52
Kette	Sram XX Eagle Transmission
Bremse	Magura MT8 SL 2 Piston disc brake
Bremse	Magura MT8 SL 2 Piston disc brake
Bremsscheibe	Braking S3 Battfly, 180mm - 6Hole
Bremsscheibe	Braking S3 Battfly, 180mm - 6Hole
Reifen	Pirelli SCORPION ProWall XC-RC - 29"x 2.2
Reifen	Pirelli SCORPION ProWall XC-RC - 29"x 2.2
Felgen und Speichen	Mavic Crossmax SL Ultimate 29"
Lenker	FANTIC RACING INTEGRATED FLAT-17°, 780mm
Vorbau	nd/na
Sattelstütze	Crankbrothers Highline 11 Ø30.9 - carbon
Sattel	Selle Italia SLR Boost Superflow
Bemerkung	(*) Optional range extender, 160Wh

Rampage 1.4 Factory

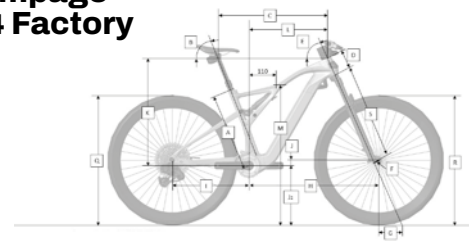

Maßnahmen	S	M	L	XL
A	410	440	470	500
B	75.00	75.00	500	500
C	585	607	633	658
D	95	105	120	130
E	64,50	65,00	65,00	65,50
F	51	51	51	51
G	121,5	118,0	118,0	114,3
H	732	748	775	794
I	437	437	437	437
J	23	23	23	23
J ₂	349	349	349	349
K	605	612	627	640
L	423.5	442.5	463.0	483.0
M	795	800	805	810
N	780	780	780	780
O	65* - 70*	65* - 70*	65* - 70*	65* - 70*
P	170	170	175	175
Q/R	29" 743mm	29" 743mm	29" 743mm	29" 743mm
S	562	562	562	562
Z	100	100	125	150

* 65 manubrio KFX SIC INTEGRATED
* 70 manubrio KFX FLAT

Motor	TQ HPR-50, Torque/Coppia: 50 Nm
Batterie	TQ integrated, Lithium Ion, 360Wh
Display	TFT top tube + remote
Rahmen	Full-Carbon, Sizes: S-M-L-XL
Gabel	Suntour AXON34 LO-RC PCS Factory
Dämpfer	Suntour EDGE PLUS 2CR
Kettenblätter	Sram 34t
Fahrrad kurbel	FSA Carbon
Schaltwerk	Sram GX AXS
Schalthebel	Sram GX AXS
Schaltkassette	Sram GX, 12V, 10-52
Kette	Sram GX
Bremse	Magura MT8 PRO 2 Piston disc brake
Bremse	Magura MT8 PRO 2 Piston disc brake
Bremsscheibe	Braking S3 Battfly, 180mm - 6Hole
Bremsscheibe	Braking S3 Battfly, 180mm - 6Hole
Reifen	Vittoria SYERRA - 29"x 2.4
Reifen	Vittoria SYERRA - 29"x 2.4
Felgen und Speichen	Mavic Crossmax SL S 29"
Lenker	FANTIC RACING INTEGRATED FLAT-17°, 780mm
Vorbau	nd/na
Sattelstütze	RockShox Rverb AXS
Sattel	Selle Italia Novus Boost X-Cross Superflow
Bemerkung	(*) Optional range extender, 160Wh

Rampage 1.2 Race

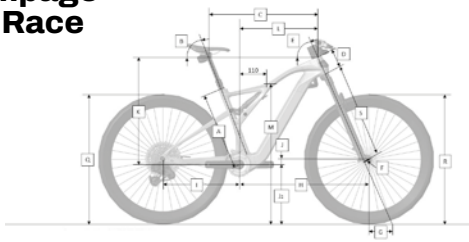

Maßnahmen	S	M	L	XL
A	410	440	470	500
B	75.00	75.00	500	500
C	585	607	633	658
D	95	105	120	130
E	64,50	65,00	65,00	65,50
F	51	51	51	51
G	121,5	118,0	118,0	114,3
H	732	748	775	794
I	437	437	437	437
J	23	23	23	23
J ₂	349	349	349	349
K	605	612	627	640
L	423.5	442.5	463.0	483.0
M	795	800	805	810
N	780	780	780	780
O	65* - 70*	65* - 70*	65* - 70*	65* - 70*
P	170	170	175	175
Q/R	29" 743mm	29" 743mm	29" 743mm	29" 743mm
S	562	562	562	562
Z	100	100	125	150

* 65 manubrio KFX SIC INTEGRATED
* 70 manubrio KFX FLAT

Motor	TQ HPR-50, Torque/Coppia: 50 Nm
Batterie	TQ integrated, Lithium Ion, 360Wh
Display	TFT top tube + remote
Rahmen	Full-Carbon, Sizes: S-M-L-XL
Gabel	RockShox SID 2P 120mm - remote lock
Dämpfer	RockShox SIDLuxe 2P - remote lock
Kettenblätter	Sram 34t
Fahrrad kurbel	FSA Forged Alloy
Schaltwerk	Sram GX AXS
Schalthebel	Sram GX AXS
Schaltkassette	Sram GX, 12V, 10-52
Kette	Sram GX
Bremse	Magura MT8 PRO 2 Piston disc brake
Bremse	Magura MT8 PRO 2 Piston disc brake
Bremsscheibe	Braking S3 Battfly, 180mm - 6Hole
Bremsscheibe	Braking S3 Battfly, 180mm - 6Hole
Reifen	Pirelli SCORPION ProWall XC-RC - 29"x 2.2
Reifen	Pirelli SCORPION ProWall XC-RC - 29"x 2.2
Felgen und Speichen	Mavic Crossmax SL S 29"
Lenker	FANTIC RACING INTEGRATED FLAT-17°, 780mm
Vorbau	nd/na
Sattelstütze	Crankbrothers Highline 3 Ø30.9
Sattel	Selle Italia Novus Boost X-Cross Superflow
Bemerkung	(*) Optional range extender, 160Wh

Rampage 1.4 Race

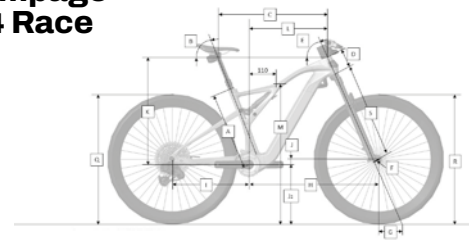

Maßnahmen	S	M	L	XL
A	410	440	470	500
B	75.00	75.00	500	500
C	585	607	633	658
D	95	105	120	130
E	64,50	65,00	65,00	65,50
F	51	51	51	51
G	121,5	118,0	118,0	114,3
H	732	748	775	794
I	437	437	437	437
J	23	23	23	23
J ₂	349	349	349	349
K	605	612	627	640
L	423.5	442.5	463.0	483.0
M	795	800	805	810
N	780	780	780	780
O	65* - 70*	65* - 70*	65* - 70*	65* - 70*
P	170	170	175	175
Q/R	29" 743mm	29" 743mm	29" 743mm	29" 743mm
S	562	562	562	562
Z	100	100	125	150

* 65 manubrio KFX SIC INTEGRATED
* 70 manubrio KFX FLAT

Motor	TQ HPR-50, Torque/Coppia: 50 Nm
Batterie	TQ integrated, Lithium Ion, 360Wh
Display	TFT top tube + remote
Rahmen	Full-Carbon, Sizes: S-M-L-XL
Gabel	Suntour AXON34 LO-RC PCS
Dämpfer	Suntour EDGE PLUS 2CR
Kettenblätter	Sram 34t
Fahrrad kurbel	FSA Forged Alloy
Schaltwerk	Sram GX
Schalthebel	Sram GX
Schaltkassette	Sram GX, 12V, 10-52
Kette	Sram GX
Bremse	Magura MT8 SPORT 2 Piston disc brake
Bremse	Magura MT8 SPORT 2 Piston disc brake
Bremsscheibe	Braking S3 Battfly, 180mm - 6Hole
Bremsscheibe	Braking S3 Battfly, 180mm - 6Hole
Reifen	Vittoria SYERRA - 29"x 2.4
Reifen	Vittoria SYERRA - 29"x 2.4
Felgen und Speichen	Mavic Crossmax SL S 29"
Lenker	GBC Ø31,8 FLAT
Vorbau	GBC Ø31,8 x 70mm +8°
Sattelstütze	Crankbrothers Highline 3 Ø30.9
Sattel	Selle Italia Model-X Superflow
Bemerkung	(*) Optional range extender, 160Wh

Rampage 1.4 Sport

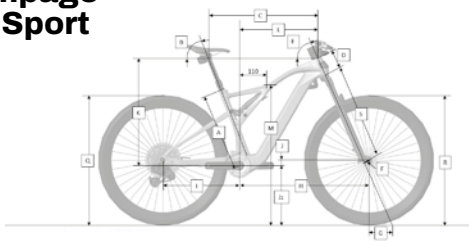

Maßnahmen	S	M	L	XL
A	410	440	470	500
B	75,00	75,00	500	500
C	585	607	633	658
D	95	105	120	130
E	64,50	65,00	65,00	65,50
F	51	51	51	51
G	121,5	118,0	118,0	114,3
H	732	748	775	794
I	437	437	437	437
J	23	23	23	23
J ₂	349	349	349	349
K	605	612	627	640
L	423,5	442,5	463,0	483,0
M	795	800	805	810
N	780	780	780	780
O	65* - 70*	65* - 70*	65* - 70*	65* - 70*
P	170	170	175	175
Q/R	29" 743mm	29" 743mm	29" 743mm	29" 743mm
S	562	562	562	562
Z	100	100	125	150

* 65 manubrio KFX SIC INTEGRATED
* 70 manubrio KFX FLAT

Motor	TQ HPR-50, Torque/Coppia: 50 Nm
Batterie	TQ integrated, Lithium Ion, 360Wh
Display	TFT top tube + remote
Rahmen	Full-Carbon, Sizes: S-M-L-XL
Gabel	Suntour RAIDON34 LOR
Dämpfer	Suntour EDGE PLUS 2CR
Kettenblätter	Sram 34t
Fahrrad kurbel	FSA Forged Alloy
Schaltwerk	Sram SX
Schalthebel	Sram SX
Schaltkassette	Sram SX, 12V, 11-50
Kette	Sram SX
Bremse	Sram LEVEL 2 Piston disc brake
Bremse	Sram LEVEL 2 Piston disc brake
Bremsscheibe	Sram CENTERLINE, 180mm - 6Hole
Bremsscheibe	Sram CENTERLINE, 180mm - 6Hole
Reifen	Vittoria SYERRA - 29"x 2.4
Reifen	Vittoria SYERRA - 29"x 2.4
Felgen und Speichen	GBC Radiale 29"
Lenker	GBC Ø31,8 FLAT
Vorbau	GBC Ø31,8 x 70mm +8"
Sattelstütze	RST ELEV8 A2 Ø30.9
Sattel	Selle Italia Model-X Superflow
Bemerkung	(*) Optional range extender, 160Wh

XTF 1.6 Carbon Race



Maßnahmen	S	M	L	XL
A	390	430	469	510
A3	73	73	73	73
B	575	596	628	655
B1	156	158	162	167
B2	419	438	466	488
B3	608,0	615,1	628,9	645,5
C	100	105	120	135
C2	568	568	568	568
C4	66	66,5	66,5	67
D1	1188	1204	1238	1260
E	456	456	456	456
F	362,5	362,5	362,5	362,5

Motor	Brose S-Mag 36, Torque/Coppia: 90 Nm
Batterie	Fantic, Lithium Ion, 36 Volt, 720Wh
Display	Brose All Round
Rahmen	Carbon, sizes: S - M - L - XL
Gabel (**)	RockShox Lyrik Select 160mm
Dämpfer	RockShox Deluxe Select+
Kettenblätter	Sram 34t
Fahrrad kurbel	FSA
Schaltwerk	Sram GX AXS Eagle
Schalthebel	Sram GX AXS
Schaltkassette	SunRace SilverRed, 12V, 11-51
Kette	Sram SX
Bremse	Sram G2 RS 4 Piston disc brake
Bremse	Sram G2 RS 4 Piston disc brake
Bremsscheibe	Braking S3 Batfly, 203mm - 6Hole
Bremsscheibe	Braking S3 Batfly, 180mm - 6Hole
Reifen	Pirelli Scorpion ProWall Trail -M- 29"x 2.4
Reifen	Pirelli Scorpion ProWall Trail -R- 29"x 2.4
Felgen und Speichen	FSA i29 Carbon 29"
Lenker	FANTIC RACING Carbon Ø31,8 Rise 25, 760mm
Vorbau	FSA NS ICR 10°AO 70mm Ø31,8
Sattelstütze	Switch SW Ø 30.9
Sattel	Selle Italia Novus Boost X-Cross Superflow
Bemerkung	(*)

(**) Alternative fork/ forcella alternativa Suntour Durolox 36

66

XTF 1.6 Carbon Factory



Maßnahmen	S	M	L	XL
A	390	430	469	510
A3	73	73	73	73
B	575	596	628	655
B1	156	158	162	167
B2	419	438	466	488
B3	608,0	615,1	628,9	645,5
C	100	105	120	135
C2	568	568	568	568
C4	66	66,5	66,5	67
D1	1188	1204	1238	1260
E	456	456	456	456
F	362,5	362,5	362,5	362,5

Motor	Brose S-Mag 36, Torque/Coppia: 90 Nm
Batterie	Fantic, Lithium Ion, 36 Volt, 720Wh
Display	Brose All Round
Rahmen	Carbon, sizes: S - M - L - XL
Gabel	RockShox Lyrik Ultimate 160mm
Dämpfer	RockShox Deluxe Ultimate
Kettenblätter	Sram 34t
Fahrrad kurbel	FSA Carbon
Schaltwerk	Sram XX1 AXS Eagle
Schalthebel	Sram XX1 AXS
Schaltkassette	Sram X-Glide Rainbow, 12V, 10-52
Kette	Sram
Bremse	Magura MT Trail Sport 4 Piston disc brake
Bremse	Magura MT Trail Sport 4 Piston disc brake
Bremsscheibe	Braking S3 Batfly, 203mm - 6Hole
Bremsscheibe	Braking S3 Batfly, 180mm - 6Hole
Reifen	Pirelli Scorpion ProWall Trail -M- 29"x 2.4
Reifen	Pirelli Scorpion ProWall Trail -R- 29"x 2.4
Felgen und Speichen	FSA KFX Carbon 29"
Lenker	FANTIC RACING INTEGRATED FLAT-17°, 780mm
Vorbau	nd/na
Sattelstütze	Rockshox Reverb AXS Ø 30.9
Sattel	Selle Italia SLR Boost Superflow
Bemerkung	(*)

67

XTF 1.6 Carbon Sport



Maßnahmen	S	M	L	XL
A	390	430	469	510
A3	73	73	73	73
B	575	596	628	655
B1	156	158	162	167
B2	419	438	466	488
B3	608,0	615,1	628,9	645,5
C	100	105	120	135
C2	568	568	568	568
C4	66	66,5	66,5	67
D1	1188	1204	1238	1260
E	456	456	456	456
F	362,5	362,5	362,5	362,5

Motor	Brose S-Mag 36, Torque/Coppia: 90 Nm
Batterie	Fantic, Lithium Ion, 36 Volt, 720Wh
Display	Brose All Round
Rahmen	Carbon, sizes: S - M - L - XL
Gabel (**)	RockShox Lyrik Select 160mm
Dämpfer	RockShox Deluxe Select+
Kettenblätter	Sram 34t
Fahrrad kurbel	Miranda 170mm
Schaltwerk	Sram GX Eagle
Schalthebel	Sram NX
Schaltkassette	Sram SX, 12V, 11-50
Kette	Sram SX
Bremse	Sram G2 RS 4 Piston disc brake
Bremse	Sram G2 RS 4 Piston disc brake
Bremsscheibe	Braking S3 Batfly, 203mm - 6Hole
Bremsscheibe	Braking S3 Batfly, 180mm - 6Hole
Reifen	Pirelli Scorpion ProWall Trail -M- 29"x 2.4
Reifen	Pirelli Scorpion ProWall Trail -R- 29"x 2.4
Felgen und Speichen	Rodi READY27 - 29"
Lenker	FSA 760mm- Ø31,8 - Rise 15mm - Sweep 6°
Vorbau	FSA 60mm- Ø31,8 - Rise +6°
Sattelstütze	Switch SW Ø 30.9
Sattel	Selle Italia X Bow Superflow
Bemerkung	(*)

(**) Alternative fork/ forcella alternativa Suntour Durolox 36

XTF 1.5 Carbon

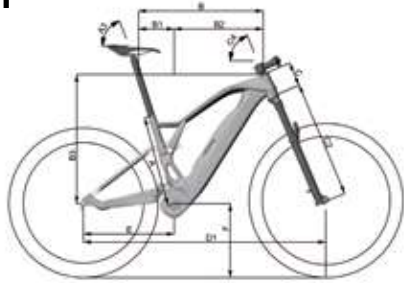

Maßnahmen	S	M	L	XL
A	390	430	469	510
A3	73	73	73	73
B	575	596	628	655
B1	156	158	162	167
B2	419	438	466	488
B3	608,0	615,1	628,9	645,5
C	100	105	120	135
C2	568	568	568	568
C4	66	66,5	66,5	67
D1	1188	1204	1238	1260
E	456	456	456	456
F	362,5	362,5	362,5	362,5

Motor	Brose S-Mag 36, Torque/Coppia: 90 Nm
Batterie	Fantic, Lithium Ion, 36 Volt, 720Wh
Display	Brose All Round
Rahmen	Carbon, sizes: S - M - L - XL
Gabel (**)	RockShox 35 Gold RL 150mm
Dämpfer	RockShox Deluxe Select+
Kettenblätter	Sram 34t
Fahrrad kurbel	FSA
Schaltwerk	Sram NX
Schalthebel	Sram NX Eagle
Schaltkassette	Sram SX, 12V, 11-51
Kette	Sram SX
Bremse	Sram Guide T 4 Piston disc brake
Bremse	Sram Guide T 4 Piston disc brake
Bremsscheibe	SramCenterLine, 200mm - 6Hole
Bremsscheibe	SramCenterLine, 180mm - 6Hole
Reifen	Pirelli Scorpion ProWall Trail -M- 29"x 2.4
Reifen	Pirelli Scorpion ProWall Trail -R- 29"x 2.4
Felgen und Speichen	Rodi READY27- 29"
Lenker	FSA 760mm- Ø31,8 - Rise 15mm - Sweep 6°
Vorbau	FSA Logo-60mm- Ø31,8 - Rise +6°
Sattelstütze	Switch SW Ø 30.9
Sattel	Selle Italia Model-X Comfort Superflow 145
Bemerkung (*)	
(**)	Alternative fork / forcella alternativa Suntour Auron 35

XTF 1.5 Sport-Y

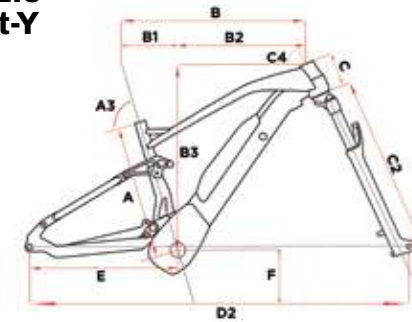

Maßnahmen	S	M	L
A	390	430	490
A3	73	73	73
B	575	602	627
B1	166	169	174
B2	407	433	453
B3	615,8	625,0	641,5
C	105	115	130
C2	567	567	567
C4	66	66	66,5
D1	1193	1224	1244
E	472	472	472
F	358	358	358

Motor	Yamaha PW X3, Torque/Coppia: 85 Nm
Batterie	Fantic, Lithium Ion, 36 Volt, 630Wh
Display	Yamaha Interface X
Rahmen	Aluminum, sizes: S - M - L
Gabel (**)	RockShox 35 Gold RL 150mm
Dämpfer	RockShox Deluxe Select+
Kettenblätter	Sram 34t
Fahrrad kurbel	FSA
Schaltwerk	Sram NX
Schalthebel	Sram NX Eagle
Schaltkassette	Sram SX, 12V, 11-50
Kette	Sram SX
Bremse	Sram Guide T 4 Piston disc brake
Bremse	Sram Guide T 4 Piston disc brake
Bremsscheibe	SramCenterLine, 200mm - 6Hole
Bremsscheibe	SramCenterLine, 180mm - 6Hole
Reifen	Pirelli Scorpion ProWall Trail -M- 29"x 2.4
Reifen	Pirelli Scorpion ProWall Trail -R- 29"x 2.4
Felgen und Speichen	Rodi TRYP30 - 29"
Lenker	Promax-760mm-Rise 18mm-Ø31,8
Vorbau	Promax-60mm-Rise +6°-Ø31,8
Sattelstütze	Switch SW Ø30.9
Sattel	Selle Italia Model-X Comfort Superflow 145
Bemerkung (*)	
(**)	Alternative fork / forcella alternativa Suntour Auron 35

68

XTF 1.5 Race-Y

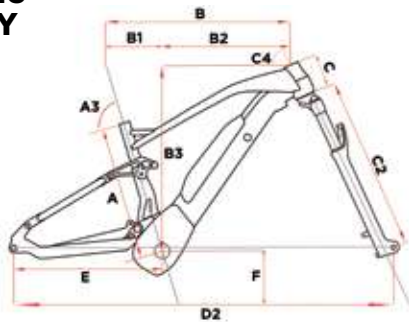

Maßnahmen	S	M	L
A	390	430	490
A3	73	73	73
B	575	602	627
B1	166	169	174
B2	407	433	453
B3	615,8	625,0	641,5
C	105	115	130
C2	567	567	567
C4	66	66	66,5
D1	1193	1224	1244
E	472	472	472
F	358	358	358

Motor	Yamaha PW X3, Torque/Coppia: 85 Nm
Batterie	Fantic, Lithium Ion, 36 Volt, 630Wh
Display	Yamaha Interface X
Rahmen	Aluminum, sizes: S - M - L
Gabel (**)	RockShox 35 Gold RL - 29" 150mm
Dämpfer	RockShox Deluxe Select+
Kettenblätter	Sram 34t
Fahrrad kurbel	FSA
Schaltwerk	Sram GX AXS
Schalthebel	Sram GX AXS Eagle
Schaltkassette	Sram SX, 12V, 11-50
Kette	Sram SX
Bremse	Sram Guide T 4 Piston disc brake
Bremse	Sram Guide T 4 Piston disc brake
Bremsscheibe	SramCenterLine, 200mm - 6Hole
Bremsscheibe	SramCenterLine, 180mm - 6Hole
Reifen	Pirelli Scorpion ProWall Trail -M- 29"x 2.4
Reifen	Pirelli Scorpion ProWall Trail -R- 29"x 2.4
Felgen und Speichen	Rodi TRYP30 - 29"
Lenker	FSA 760mm- Ø31,8 - Rise 15mm - Sweep 6°
Vorbau	FSA Logo-60mm- Ø31,8 - Rise +6°
Sattelstütze	Switch SW Ø 30.9, S - 80mm / M - 100mm / L - 125mm
Sattel	Selle Italia Model-X Comfort Superflow 145
Bemerkung (*)	
(**)	Alternative fork / forcella alternativa Suntour Auron 35

69

XTF 1.5 All Track

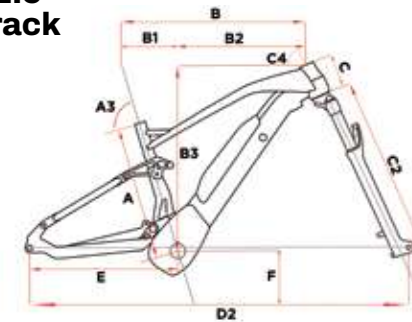

Maßnahmen	S	M	L
A	390	430	490
A3	73	73	73
B	575	602	627
B1	166	169	174
B2	407	433	453
B3	615,8	625,0	641,5
C	105	115	130
C2	567	567	567
C4	66	66	66,5
D1	1193	1224	1244
E	472	472	472
F	358	358	358

Motor	Yamaha PW X3, Torque/Coppia: 85 Nm
Batterie	Fantic, Lithium Ion, 36 Volt, 630Wh
Display	Yamaha Interface X
Rahmen	Aluminum, sizes: S - M - L
Gabel (**)	RockShox Recon Silver RL 150mm
Dämpfer	RockShox Deluxe Select
Kettenblätter	Sram 34t
Fahrrad kurbel	FSA
Schaltwerk	Sram SX
Schalthebel	Sram SX Eagle
Schaltkassette	Sram SX, 12V, 11-50
Kette	Sram SX
Bremse	Sram Level 2 Piston disc brake
Bremse	Sram Level 2 Piston disc brake
Bremsscheibe	SramCenterLine, 200mm - 6Hole
Bremsscheibe	SramCenterLine, 180mm - 6Hole
Reifen	Pirelli Scorpion ProWall Trail -M- 29"x 2.4
Reifen	Pirelli Scorpion ProWall Trail -R- 29"x 2.4
Felgen und Speichen	Rodi TRYP30 - 29"
Lenker	Promax-760mm-Rise 18mm-Ø31,8
Vorbau	Promax-60mm-Rise+6°-Ø31,8
Sattelstütze	Switch SW Ø30.9
Sattel	Selle Italia Model-X Comfort Superflow 145
Bemerkung (*)	
(**)	Alternative fork / forcella alternativa Suntour Auron 35

XTF 1.5 Y

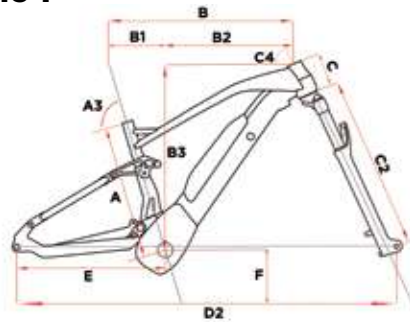

Maßnahmen	S	M	L
A	390	430	490
A3	73	73	73
B	575	602	627
B1	166	169	174
B2	407	433	453
B3	615,8	625,0	641,5
C	105	115	130
C2	567	567	567
C4	66	66	66,5
D1	1193	1224	1244
E	472	472	472
F	358	358	358

Motor	Brose S-Alu, Torque/Coppia: 90 Nm
Batterie	Fantic, Lithium Ion, 36 Volt, 630Wh
Display	Brose All Round
Rahmen	Aluminum, Sizes: S - M - L
Gabel (**)	RockShox 35 Gold RL 150mm
Dämpfer	RockShox Deluxe Select+
Kettenblätter	Sram 34t
Fahrrad kurbel	Miranda 165mm
Schaltwerk	Sram GX AXS
Schalthebel	Sram GX AXS Eagle
Schaltkassette	Sram SX, 12V, 11-50
Kette	Sram SX
Bremse	Sram GUIDE T 4 Piston disc brake
Bremse	Sram GUIDE T 4 Piston disc brake
Bremsscheibe	SramCenterLine, 200mm - 6Hole
Bremsscheibe	SramCenterLine, 180mm - 6Hole
Reifen	Pirelli SCORPION ProWall Trail -M- 29"x 2.4
Reifen	Pirelli SCORPION ProWall Trail -R- 29"x 2.4
Felgen und Speichen	Rodi TRYP30
Lenker	FSA Ø31,8 - Rise15mm - Sweep 6°
Vorbau	FSA - Ø31,8 - 80mm - Rise ±6°
Sattelstütze	Switch SW Ø30.9
Sattel	Selle Italia MODEL-X Comfort Superflow 145
Bemerkung (*)	
(**)	Alternative fork / forcella alternativa Suntour Auron 35

XTF 1.5 Sport

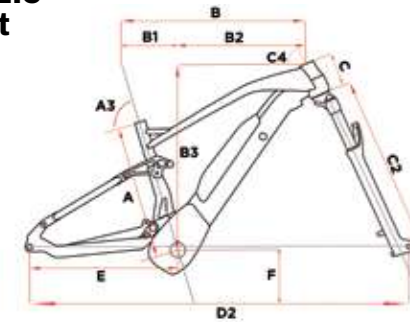

Maßnahmen	S	M	L
A	390	430	490
A3	73	73	73
B	575	602	627
B1	166	169	174
B2	407	433	453
B3	615,8	625,0	641,5
C	105	115	130
C2	567	567	567
C4	66	66	66,5
D1	1193	1224	1244
E	472	472	472
F	358	358	358

Motor	Brose S-Alu, Torque/Coppia: 90 Nm
Batterie	Fantic, Lithium Ion, 36 Volt, 630Wh
Display	Brose All Round
Rahmen	Aluminum, sizes: S - M - L
Gabel (**)	RockShox 35 Gold RL 150mm
Dämpfer	RockShox Deluxe Select+
Kettenblätter	Sram 34t
Fahrrad kurbel	Miranda
Schaltwerk	Sram NX
Schalthebel	Sram NX Eagle
Schaltkassette	Sram SX, 12V, 11-50
Kette	Sram SX
Bremse	Sram Guide T 4 Piston disc brake
Bremse	Sram Guide T 4 Piston disc brake
Bremsscheibe	SramCenterLine, 200mm - 6Hole
Bremsscheibe	SramCenterLine, 180mm - 6Hole
Reifen	Pirelli Scorpion Trail -S- 29"x 2.4
Reifen	Pirelli Scorpion Trail -R- 29"x 2.4
Felgen und Speichen	Rodi TRYP30
Lenker	Promax ø31,8 760mm Rise 20mm
Vorbau	Promax 60MM ±6° ø31,8
Sattelstütze	Promax teles. SP-2038 Ø 30,9, S 80mm / M-L 100mm
Sattel	Selle Italia Model-X Comfort Superflow 145
Bemerkung (*)	
(**)	Alternative fork / forcella alternativa Suntour Auron 35

70

XTF 1.5 Race

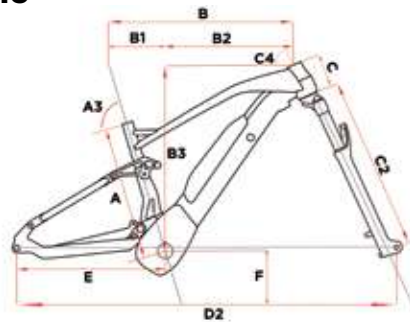

Maßnahmen	S	M	L
A	390	430	490
A3	73	73	73
B	575	602	627
B1	166	169	174
B2	407	433	453
B3	615,8	625,0	641,5
C	105	115	130
C2	567	567	567
C4	66	66	66,5
D1	1193	1224	1244
E	472	472	472
F	358	358	358

Motor	Brose S-Alu, Torque/Coppia: 90 Nm
Batterie	Fantic, Lithium Ion, 36 Volt, 630Wh
Display	Brose All Round
Rahmen	Aluminum, sizes: S - M - L
Gabel (**)	RockShox 35 Gold RL 150mm
Dämpfer	RockShox Deluxe Select+
Kettenblätter	Sram 34t
Fahrrad kurbel	Miranda 165mm
Schaltwerk	Sram GX AXS
Schalthebel	Sram GX AXS Eagle
Schaltkassette	Sram SX, 12V, 11-50
Kette	Sram SX
Bremse	Sram Guide T 4 Piston disc brake
Bremse	Sram Guide T 4 Piston disc brake
Bremsscheibe	SramCenterLine, 200mm - 6Hole
Bremsscheibe	SramCenterLine, 180mm - 6Hole
Reifen	Pirelli Scorpion Trail -S- 29"x 2.4
Reifen	Pirelli Scorpion Trail -R- 29"x 2.4
Felgen und Speichen	Rodi TRYP30
Lenker	FSA Ø31,8 - Rise15mm - Sweep 6°
Vorbau	FSA Logo Ø31,8 - Rise +6°
Sattelstütze	Switch SW Ø 30,9, S - 80mm / M - 100mm / L - 125mm
Sattel	Selle Italia Model-X Comfort Superflow 145
Bemerkung (*)	
(**)	Alternative fork / forcella alternativa Suntour Auron 35

XTF 1.5

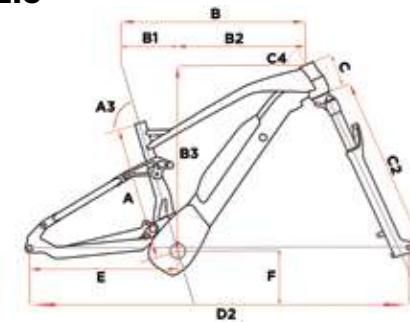

Maßnahmen	S	M	L
A	390	430	490
A3	73	73	73
B	575	602	627
B1	166	169	174
B2	407	433	453
B3	615,8	625,0	641,5
C	105	115	130
C2	567	567	567
C4	66	66	66,5
D1	1193	1224	1244
E	472	472	472
F	358	358	358

Motor	Brose S-Alu, Torque/Coppia: 90 Nm
Batterie	Fantic, Lithium Ion, 36 Volt, 630Wh
Display	Brose All Round
Rahmen	Aluminum, sizes: S - M - L
Gabel (**)	RockShox Recon Silver RL 150mm
Dämpfer	RockShox Deluxe Select
Kettenblätter	Sram 34t
Fahrrad kurbel	Miranda
Schaltwerk	Sram SX
Schalthebel	Sram SX Eagle
Schaltkassette	Sram SX, 12V, 11-50
Kette	Sram SX
Bremse	Sram Level 2 Piston disc brake
Bremse	Sram Level 2 Piston disc brake
Bremsscheibe	SramCenterLine, 200mm - 6Hole
Bremsscheibe	SramCenterLine, 180mm - 6Hole
Reifen	Pirelli Scorpion ProWall 29"x 2.4
Reifen	Pirelli Scorpion ProWall 29"x 2.4
Felgen und Speichen	Rodi TRYP30
Lenker	Promax ø31,8 760mm Rise 20mm
Vorbau	Promax 60MM ±6° ø31,8
Sattelstütze	Promax teles. SP-2038 Ø 30,9, S 80mm / M-L 100mm
Sattel	Selle Italia Model-X Comfort Superflow 145
Bemerkung (*)	
(**)	Alternative fork / forcella alternativa Suntour Auron 35

71

XMf 1.7 Carbon Race

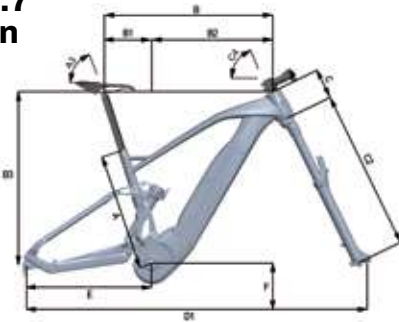

Maßnahmen	S	M	L
A	390	430	490
A3	73	73	73
B	586	596	628
B1	161	162	166
B2	425	454	480
B3	617,8	622,0	633,7
C	105	110	120
C2	581	581	581
C4	65	65	65,5
D1	1241	1245	1270,5
E	459	459	459
F	363,5	363,5	363,5

Motor	Brose S-Mag 36, Torque/Coppia: 90 Nm
Batterie	Fantic, Lithium Ion, 36 Volt, 720Wh
Display	Brose All Round
Rahmen	Carbon, sizes: S - M - L
Gabel	RockShox Zeb Select 170mm
Dämpfer	RockShox SuperDeluxe Select+
Kettenblätter	Sram 34t
Fahrrad kurbel	FSA 165mm
Schaltwerk	Sram GX
Schalthebel	Sram GX AXS Eagle
Schaltkassette	Sram SX, 12V, 11-50
Kette	Sram SX
Bremse	Magura MT7 4 Piston disc brake
Bremse	Magura MT7 4 Piston disc brake
Bremsscheibe	Braking S3 Battfly, 220mm - 6Hole
Bremsscheibe	Braking S3 Battfly, 203mm - 6Hole
Reifen	Vittoria E-Martello 29"x 2.35
Reifen	Vittoria E-Martello 27,5"x 2.6
Felgen und Speichen	Fulcrum E-Fire 500 29"-27.5"
Lenker	Fantic Racing-800mm - Ø35 - Rise 20mm
Vorbau	Fantic Racing - 50mm - Ø35
Sattelstütze	Crankbrothers Highline7 Ø 30.9
Sattel	Selle Italia Novus Boost X-Cross Superflow
Bemerkung	(*)

XMf 1.7

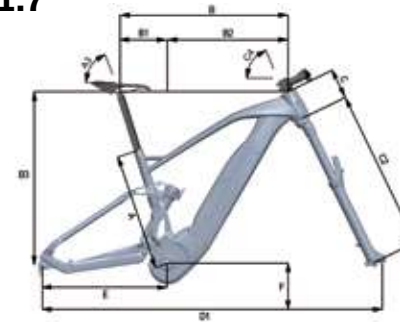

Maßnahmen	S	M	L
A	390	430	490
A3	73	73	73
B	586	596	628
B1	161	162	166
B2	425	454	480
B3	617,8	622,0	633,7
C	105	110	120
C2	581	581	581
C4	65	65	65,5
D1	1241	1245	1270,5
E	459	459	459
F	363,5	363,5	363,5

Motor	Brose S-Mag 36, Torque/Coppia: 90 Nm
Batterie	Fantic, Lithium Ion, 36 Volt, 720Wh
Display	Brose All Round
Rahmen	Aluminum, sizes: S - M - L
Gabel (**)	RockShox Domain R 170mm
Dämpfer	RockShox Deluxe Select+
Kettenblätter	Sram 34t
Fahrrad kurbel	FSA
Schaltwerk	Sram NX
Schalthebel	Sram NX Eagle
Schaltkassette	Sram SX, 12V, 11-50
Kette	Sram SX
Bremse	Sram Guide T 4 Piston disc brake
Bremse	Sram Guide T 4 Piston disc brake
Bremsscheibe	SramCenterLine, 220mm - 6Hole
Bremsscheibe	SramCenterLine, 200mm - 6Hole
Reifen	Vittoria E-Martello 29"x 2.35
Reifen	Vittoria E-Martello 27,5"x 2.6
Felgen und Speichen	Fulcrum E-Fire 700 29"-27.5"
Lenker	FSA Comet-800mm - Ø35 - Rise 15mm
Vorbau	FSA Comet-50mm - Ø35 - Rise +6°
Sattelstütze	Switch SW Ø 30.9 S-M, L
Sattel	Selle Italia Model X Comfort Superflow 145
Bemerkung	(*)
(**)	Alternative fork / forcella alternativa Suntour DuroLux 36

72

XMf 1.7 Carbon Sport

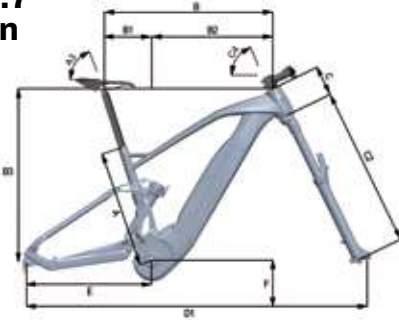

Maßnahmen	S	M	L
A	390	430	490
A3	73	73	73
B	586	596	628
B1	161	162	166
B2	425	454	480
B3	617,8	622,0	633,7
C	105	110	120
C2	581	581	581
C4	65	65	65,5
D1	1241	1245	1270,5
E	459	459	459
F	363,5	363,5	363,5

Motor	Brose S-Mag 36, Torque/Coppia: 90 Nm
Batterie	Fantic, Lithium Ion, 36 Volt, 720Wh
Display	Brose All Round
Rahmen	Carbon, sizes: S - M - L
Gabel (**)	Suntour DuroLux 38
Dämpfer	RockShox SuperDeluxe Select+
Kettenblätter	Sram 34t
Fahrrad kurbel	FSA
Schaltwerk	Sram GX
Schalthebel	Sram NX Eagle
Schaltkassette	Sram SX, 12V, 11-50
Kette	Sram SX
Bremse	Sram Code R 4 Piston disc brake
Bremse	Sram Code R 4 Piston disc brake
Bremsscheibe	Braking S3 Battfly, 220mm - 6Hole
Bremsscheibe	Braking S3 Battfly, 203mm - 6Hole
Reifen	Vittoria E-MARTELLLO 29"x 2.35
Reifen	Vittoria E-Martello 27,5"x 2.6
Felgen und Speichen	Fulcrum E-Fire 700 29"-27.5"
Lenker	FSA Grid - 800mm - Ø35 - Rise 15mm
Vorbau	FSA Grid-50mm- Ø35 - Rise +6°
Sattelstütze	Switch SW Ø 30.9
Sattel	Selle Italia X Bow Superflow
Bemerkung	(*)
(**)	Alternative fork / forcella alternativa RockShox Domain R 170mm

XEF 1.9 Factory

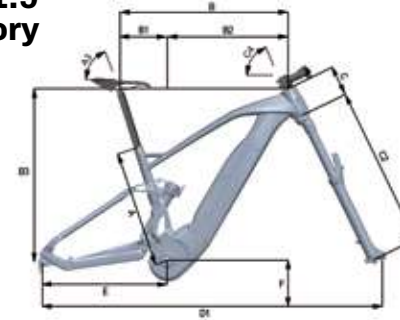

Maßnahmen	S	M	L
A	390	430	490
A3	73	73	73
B	586	596	628
B1	161	162	166
B2	425	454	480
B3	617,8	622,0	633,7
C	105	110	120
C2	581	581	581
C4	65	65	65,5
D1	1241	1245	1270,5
E	459	459	459
F	363,5	363,5	363,5

Motor	Brose S-Mag 36, Torque/Coppia: 90 Nm
Batterie	Fantic, Lithium Ion, 36 Volt, 720Wh
Display	Brose Remote
Rahmen	Aluminum, sizes: S - M - L
Gabel	RockShox Zeb Ultimate 190mm
Dämpfer	Ohlins TTX 22M
Kettenblätter	Sram 34t
Fahrrad kurbel	FSA
Schaltwerk	Sram GX AXS
Schalthebel	Sram GX AXS Eagle
Schaltkassette	SunRace SilverRed, 12V, 11-51
Kette	Sram NX
Bremse	Braking IN.CA.S disc brake
Bremse	Braking IN.CA.S disc brake
Bremsscheibe	Braking S3 Battfly, 220mm - 6Hole
Bremsscheibe	Braking S3 Battfly, 203mm - 6Hole
Reifen	Vittoria E-Mazza 29"x 2.6
Reifen	Vittoria E-Martello 27,5"x 2.8
Felgen und Speichen	Mavic E-Deemax 29"- 27.5"
Lenker	Fantic Racing-800mm- Ø35 - Rise 20mm -Sand
Vorbau	Fantic Racing-35mm- Ø35
Sattelstütze	Crankbrothers HIGHLIGHT7 Ø 30.9
Sattel	Selle Italia Novus Boost X Cross Superflow
Bemerkung	(*)

73

XE1.9 Race

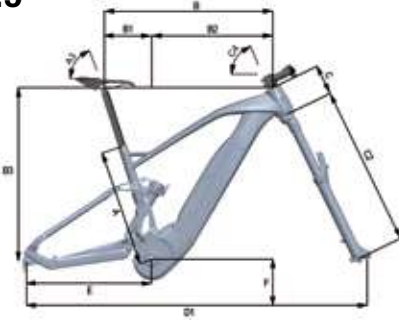

Maßnahmen	S	M	L
A	390	430	490
A3	73	73	73
B	586	596	628
B1	161	162	166
B2	425	454	480
B3	617,8	622,0	633,7
C	105	110	120
C2	581	581	581
C4	65	65	65,5
D1	1241	1245	1270,5
E	459	459	459
F	363,5	363,5	363,5

Motor	Brose S-Mag 36, Torque/Coppia: 90 Nm
Batterie	Fantic, Lithium Ion, 36 Volt, 720Wh
Display	Brose Remote
Rahmen	Aluminum, sizes: S - M - L
Gabel (**)	RockShox Zeb Select 190mm
Dämpfer	RockShox SuperDeluxe Coil Select+
Kettenblätter	Sram 34t
Fahrrad kurbel	FSA
Schaltwerk	Sram GX
Schalthebel	Sram GX Eagle
Schaltkassette	Sram SX, 12V, 11-50
Kette	Sram NX
Bremse	Magura MT7 4 Piston disc brake
Bremse	Magura MT7 4 Piston disc brake
Bremsscheibe	Braking S3 Battfly, 220mm - 6Hole
Bremsscheibe	Braking S3 Battfly, 203mm - 6Hole
Reifen	Vittoria E-Mazza 29"x 2.6
Reifen	Vittoria E-Martello 27,5"x 2.8
Felgen und Speichen	Mavic E-Deemax 29"- 27.5"
Lenker	FSA Gradient-800mm- Ø35 - Rise 15mm
Vorbau	FSA Gradient-35mm- Ø35 - Rise +6°
Sattelstütze	Crankbrothers HIGHLIGHT7 Ø 30.9 S-M, L
Sattel	Selle Italia Model-X Bow Superflow
Bemerkung	(*)
(**)	Alternative fork / forcella alternativa Suntour Durolox 38 180mm

XXF 2.0 Factory

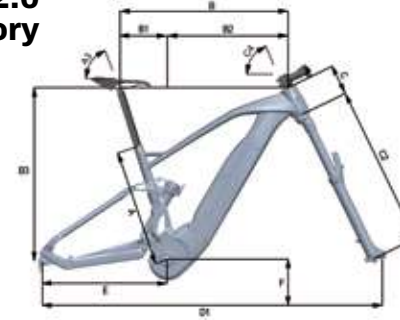

Maßnahmen	S	M	L
A	390	430	490
A3	73	73	73
B	586	596	628
B1	161	162	166
B2	425	454	480
B3	617,8	622,0	633,7
C	105	110	120
C2	581	581	581
C4	65	65	65,5
D1	1241	1245	1270,5
E	459	459	459
F	363,5	363,5	363,5

Motor	Brose S-Mag 36, Torque/Coppia: 90 Nm
Batterie	Fantic, Lithium Ion, 36 Volt, 720Wh
Display	Brose Remote
Rahmen	Aluminum, sizes: S - M - L
Gabel	Ohlins DH 38 200mm
Dämpfer	Ohlins TTX 22M
Kettenblätter	Sram 34t
Fahrrad kurbel	FSA
Schaltwerk	Sram GX
Schalthebel	Sram GX Eagle
Schaltkassette	SunRace SilverRed, 12V, 11-51
Kette	Sram NX
Bremse	Braking IN.CA.S disc brake
Bremse	Braking IN.CA.S disc brake
Bremsscheibe	Braking S3 Battfly, 220mm - 6Hole
Bremsscheibe	Braking S3 Battfly, 203mm - 6Hole
Reifen	Vittoria E-Mazza 29"x 2.6
Reifen	Vittoria E-Martello 27,5"x 2.8
Felgen und Speichen	Mavic E-Deemax 29"- 27.5"
Lenker	Fantic Racing-800mm- Ø35 - Rise 30mm -Sand
Vorbau	Fantic Racing Diretto -35mm- Ø35
Sattelstütze	Crankbrothers HIGHLIGHT7 Ø 30.9
Sattel	Selle Italia Novus Boost X Cross Superflow
Bemerkung	(*)

74

XE1.8 Sport

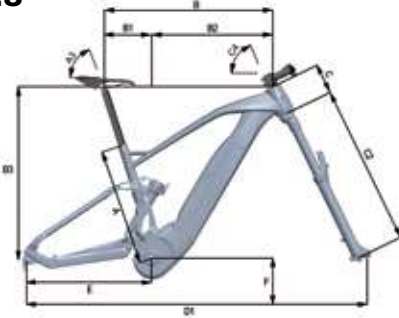

Maßnahmen	S	M	L
A	390	430	490
A3	73	73	73
B	586	596	628
B1	161	162	166
B2	425	454	480
B3	617,8	622,0	633,7
C	105	110	120
C2	581	581	581
C4	65	65	65,5
D1	1241	1245	1270,5
E	459	459	459
F	363,5	363,5	363,5

Motor	Brose S-Mag 36, Torque/Coppia: 90 Nm
Batterie	Fantic, Lithium Ion, 36 Volt, 720Wh
Display	Brose Remote
Rahmen	Aluminum, sizes: S - M - L
Gabel	RockShox Domain R 180mm
Dämpfer	RockShox SuperDeluxe Coil Select+
Kettenblätter	Sram 34t
Fahrrad kurbel	FSA
Schaltwerk	Sram NX
Schalthebel	Sram NX Eagle
Schaltkassette	Sram SX, 12V, 11-50
Kette	Sram NX
Bremse	Sram Code R 4 Piston disc brake
Bremse	Sram Code R 4 Piston disc brake
Bremsscheibe	Braking S3 Battfly, 220mm - 6Hole
Bremsscheibe	Braking S3 Battfly, 203mm - 6Hole
Reifen	Vittoria E-Mazza 29"x 2.6
Reifen	Vittoria E-Martello 27,5"x 2.8
Felgen und Speichen	Mavic E-Deemax 29"- 27.5"
Lenker	FSA Comet-800mm- Ø35 - Rise 25mm
Vorbau	FSA Comet-35mm- Ø35 - Rise +6°
Sattelstütze	Switch SW Ø 30.9
Sattel	Selle Italia Model-X Comfort Superflow 145
Bemerkung	(*)

XXF 2.0 Race

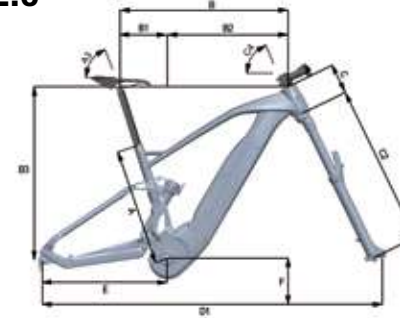

Maßnahmen	S	M	L
A	390	430	490
A3	73	73	73
B	586	596	628
B1	161	162	166
B2	425	454	480
B3	617,8	622,0	633,7
C	105	110	120
C2	581	581	581
C4	65	65	65,5
D1	1241	1245	1270,5
E	459	459	459
F	363,5	363,5	363,5

Motor	Brose S-Mag, Torque/Coppia: 90 Nm
Batterie	Fantic, Lithium Ion, 36 Volt, 720Wh
Display	Brose Remote
Rahmen	Aluminum, sizes: S - M - L
Gabel	RockShox Boxxer Select, 200mm
Dämpfer	RockShox SuperDeluxe Coil Select+
Kettenblätter	Sram 34t
Fahrrad kurbel	FSA
Schaltwerk	Sram NX
Schalthebel	Sram NX Eagle
Schaltkassette	Sram SX Eagle 12V, 11-50
Kette	Sram NX
Bremse	Magura MT7 4 Piston disc brake
Bremse	Magura MT7 4 Piston disc brake
Bremsscheibe	Braking S3 Battfly, 220mm - 6Hole
Bremsscheibe	Braking S3 Battfly, 203mm - 6Hole
Reifen	Vittoria E-Mazza 29"x 2.6
Reifen	Vittoria E-Martello 27,5"x 2.8
Felgen und Speichen	Mavic E-Deemax 29"- 27.5"
Lenker	FSA Gradient-800mm- Ø35 - Rise 25mm
Vorbau	FSA Gradient Direct - Ø35 - 45mm
Sattelstütze	Switch SW Ø 30.9
Sattel	Selle Italia Model-X Comfort Superflow
Bemerkung	(*)

75

Fat Sport

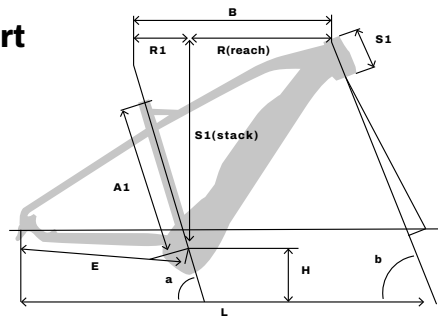

Maßnahmen	S	M	L
A	410	450	490
B	584	605	630
E	490	490	490
H	324	324	324
H1	56	56	56
L	1175	1179	1187
R	406	418	422
R1	175	187,5	207,5
S	610	613	638
S1	120	120	145
a	74°	73°	72°
b	68°	68,5°	69°

Motor	Brose T-Alu, Torque/Coppia: 70 Nm
Batterie	Fantic, Lithium Ion, 36 Volt, 630Wh
Display	Brose All Round
Rahmen	Aluminium, sizes: S - M - L
Gabel	RockShox Bluto, 120mm
Fahrrad kurbel	Miranda
Schaltung	Sram SX
Schaltkassette	Sram SX Eagle 12V 11-50
Kette	Sram SX
Vorderradbremse	Sram Level, 2P, Hydraulic Disc Brake, 200mm disc
Hinterradbremse	Sram Level, 2P, Hydraulic Disc Brake, 180mm disc
Reifen	Schwalbe Jumbo-Jim, 26 X 4"
Felgen und Speichen	Gipiemme 26"
Vorderradnabe	Gipiemme thru axle 15mm
Hinterradnabe	Gipiemme thru axle 12mm
Lenker	FSA Ø31,8 -760m- Rise 15mm
Vorbau	FSA Logo - Ø31,8 - 60mm - Rise ±6°
Sattelstütze	FSA Ø30.9
Sattel	Selle Italia Model X Comfort superflow
Bemerkung	(*)

Seven Days Living

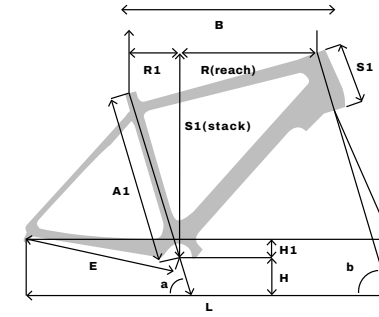

Maßnahmen	S	M	L
A1	410	450	490
B	580,5	605,5	630,7
E	465,2	465,2	465
H	309,5	309,5	309,5
H1	50,5	50,5	50,5
L	1152,7	1161,1	1169,6
R	403,5	413,5	417,5
R1	177	192	212
S	616,9	628,7	654,5
S1	110	120	145
a	73,7°	72,8°	71,8°
b	67,8°	68,3°	68,8°

Motor	Brose T-Alu, Torque/Coppia: 70Nm
Batterie	Fantic, Lithium Ion, 36 Volt, 630Wh
Display	Brose All Round
Rahmen	Aluminium, sizes: S-M-L
Gabel	RockShox Recon 29, 100mm
Fahrrad kurbel	Miranda
Schaltung	Sram SX Eagle
Schaltkassette	Sram SX, 12V, 11-50
Kette	Sram SX
Vorderradbremse	Sram Level steel hydraulic 2P, 180mm disc
Hinterradbremse	Sram Level steel hydraulic 2P, 180mm disc
Reifen	Vittoria E-Randonneur
Felgen und Speichen	GBC, Aluminium, 28"
Vorderradnabe	GBC, 110mm Boost
Hinterradnabe	GBC, 148mm Boost
Lenker	GBC Over Back - 680mm, RISE 25mm
Vorbau	GBC Ahead Set over - 70MM
Sattel & Griffe	Selle Italia ST 5 GF / Urban Gist
Pedale	Aluminium
Bemerkung	(*)

76

Integra XF2

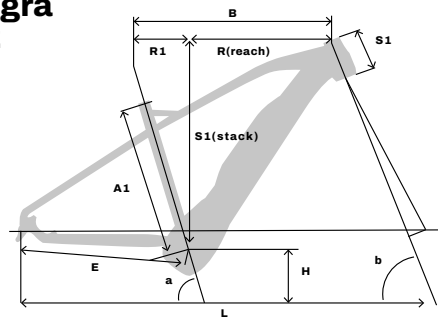

Maßnahmen	S	M	L
A	410	450	490
B	584	605	630
E	490	490	490
H	324	324	324
H1	56	56	56
L	1175	1179	1187
R	406	418	422
R1	175	187,5	207,5
S	610	613	638
S1	120	120	145
a	74°	73°	72°
b	68°	68,5°	69°

Motor	Brose T-Alu, Torque/Coppia: 70 Nm
Batterie	Fantic, Lithium Ion, 36 Volt, 630Wh
Display	Brose All Round
Rahmen	Aluminium, sizes: S - M - L
Gabel	RockShox Recon Silver RL, 120mm
Fahrrad kurbel	Miranda
Schaltung	Sram SX Eagle
Schaltkassette	Sram SX, 12V, 11-50
Kette	Sram SX
Vorderradbremse	Sram Level, 2P, Hydraulic Disc Brake, 200mm disc
Hinterradbremse	Sram Level, 2P, Hydraulic Disc Brake, 180mm disc
Reifen	Vittoria Barzo, front 29"x 2.25" / Rear 27.5" x 2.6"
Felgen und Speichen	Gipiemme, tubeless ready
Vorderradnabe	Gipiemme N28, 110mm, boost, thru axle 15mm
Hinterradnabe	Gipiemme N33, 148mm, boost, thru axle 12mm
Lenker	FSA Ø31,8 -760m- Rise 15mm
Vorbau	FSA Logo - Ø31,8 - 60mm - Rise ±6°
Sattelstütze	FSA
Sattel	Selle Italia Model X Comfort superflow
Bemerkung	(*)

77

Seven Days Living Easy

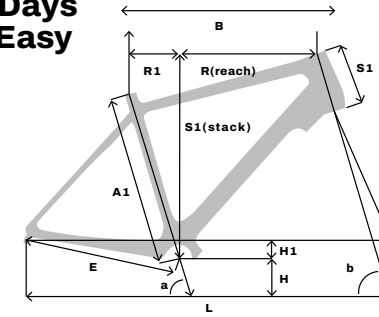

Maßnahmen	S	M	L
A1	410	450	490
B	580,5	605,5	630,7
E	465,2	465,2	465
H	309,5	309,5	309,5
H1	50,5	50,5	50,5
L	1152,7	1161,1	1169,6
R	403,5	413,5	417,5
R1	177	192	212
S	616,9	628,7	654,5
S1	110	120	145
a	73,7°	72,8°	71,8°
b	67,8°	68,3°	68,8°

Motor	Brose T, Torque/Coppia: 70Nm
Batterie	Fantic, Lithium Ion, 36 Volt, 630Wh
Display	Brose All Round
Rahmen	Aluminium, sizes: S/M - L/XL
Gabel	RockShox Recon 29, 100mm
Fahrrad kurbel	Miranda
Schaltung	Sram SX Eagle
Schaltkassette	Sram SX, 12V, 11-50
Kette	Sram SX
Vorderradbremse	Sram Level steel hydraulic 2P, 180mm disc
Hinterradbremse	Sram Level steel hydraulic 2P, 180mm disc
Reifen	Vittoria E-Randonneur
Felgen und Speichen	GBC, Aluminium, 28"
Vorderradnabe	GBC, 110mm Boost
Hinterradnabe	GBC, 148mm Boost
Lenker	GBC Over Back - 680mm, RISE 25mm
Vorbau	GBC Ahead Set over - 70MM
Sattel & Griffe	Selle Italia ST 5 GF / Urban Gist
Pedale	Aluminium
Bemerkung	(*)

Living



Maßnahmen	S	M	L
A	430	460	495
A2	72	72	72
B	575	600	620
B1	204	201	216
Reach	371	399	404
Stack	628	618	665
W	28"	28"	28"
C	130	150	170
C1	2	2	2
C2	490	460	490
C3 Trail	92,6	92,2	92,6
C4	69	69	69
R	44	44	44
D	638	662	685
D1	1102	1126	1149
D2	1830	1854	1877
E	471	471,2	471
E1	467	467	467
F	301	301	301
F1	63	63	63
Lever	170	170	170
Stem	70	100	70
Bar	700	700	700
Regg.	350	350	350

Motor	Yamaha PW S2, Torque/Coppia: 75Nm
Batterie	Fantic, Lithium Ion, 36 Volt, 630Wh
Display	Display A Yamaha / Display B Yamaha (depending on availability)
Rahmen	Aluminium, sizes: S - M - L
Gabel	Suntour XCR34, travel 100mm
Fahrrad kurbel	FSA
Schaltung	Sram SX Eagle
Schaltkassette	Sram SX, 12V, 11-50
Kette	Sram SX
Vorderradbremse	Promax Solve ST 925 hydraulic 2P, 180mm disc
Hinterradbremse	Promax Solve ST 925 hydraulic 2P, 180mm disc
Reifen	Vittoria E-Randonneur
Felgen und Speichen	GBC 29"
Vorderradnabe	GBC, 110mm Boost
Hinterradnabe	GBC, 148mm Boost
Lenker	GBC 700mm, Rise 20mm
Vorbau	GBC 70mm
Sattel	Selle Italia S5 Superflow
Sattelstütze	Promax Suspended Ø30.9
Griffe	Urban Gist
Pedale	Aluminium
Vordere lampe	Busch Muller
Rücklicht	Trelock
Vorhängeschloss	Abus
Bemerkung	(*)

Living City



Maßnahmen	S	M	L
A	430	460	500
A2	72	72	72
B	575	600	625
B1	201	201	207
Reach	374	399	418
Stack	618	618	637
W	27,5"	28"	28"
C	150	150	170
C1	2	2	2
C2	460	460	460
C3 Trail	84,15	92,2	92,2
C4	69	69	69
R	44	44	44
D	637,5	662	688
D1	1101	1126	1152,5
D2	1785	1854	1880,5
E	471,2	471,2	471,2
E1	467	467	467
F	279	301	301
F1	63	63	63
Lever	170	170	170
Stem	100	100	100
Bar	700	700	700
Regg.	350	350	350

Motor	Yamaha PW S2, Torque/Coppia: 75Nm
Batterie	Fantic, Lithium Ion, 36 Volt, 630Wh
Display	Display A Yamaha / Display B Yamaha (depending on availability)
Rahmen	Aluminium, sizes: S - M - L
Gabel	RST Volant, travel 50mm
Schaltung	Enviolo City
Fahrrad kurbel	FSA
Vorderradbremse	Promax Solve ST 925 hydraulic 2P, 180mm disc
Hinterradbremse	Promax Solve ST 925 hydraulic 2P, 180mm disc
Reifen	Vittoria E-Randonneur
Felgen und Speichen	GBC 29" (M-L) - 27.5" (S)
Vorderradnabe	GBC, 110mm Boost
Hinterradnabe	GBC, 148mm Boost
Lenker	GBC 700mm, Rise 20mm
Vorbau	GBC 70mm
Sattel	Selle Italia T3 Flow
Sattelstütze	Promax Suspended Ø30.9
Pedale	Aluminium
Vordere lampe	Busch Muller
Rücklicht	Trelock
Vorhängeschloss	Abus
Bemerkung	(*)

78

Living Easy



Maßnahmen	S-M	L-XL
A	430	495
A2	72	72
B	575	595
B1	210	216
Reach	365	379
Stack	646,5	665
W	28"	28"
C	150	170
C1	2	2
C2	490	490
C3 Trail	92,6	92,6
C4	69	69
R	44	44
D	639	660
D1	1103	1124
D2	1831	1852
E	471,2	471,2
E1	467	467
F	301	301
F1	63	63
Lever	170	170
Stem	70	70
Bar	700	700
Regg.	350	350

Motor	Yamaha PW S2, Torque/Coppia: 75Nm
Batterie	Fantic, Lithium Ion, 36 Volt, 630Wh
Display	Display A Yamaha / Display B Yamaha (depending on availability)
Rahmen	Aluminium, sizes: S-M / L-XL
Gabel	Suntour XCR34, travel 100mm
Fahrrad kurbel	FSA
Schaltung	Sram SX Eagle
Schaltkassette	Sram SX, 12V, 11-50
Kette	Sram SX
Vorderradbremse	Promax Solve ST 925 hydraulic 2P, 180mm disc
Hinterradbremse	Promax Solve ST 925 hydraulic 2P, 180mm disc
Reifen	Vittoria E-Randonneur
Felgen und Speichen	GBC 29"
Vorderradnabe	GBC, 110mm Boost
Hinterradnabe	GBC, 148mm Boost
Lenker	GBC 700mm, Rise 20mm
Vorbau	GBC 70mm
Sattel	Selle Italia Max S5 Superflow
Sattelstütze	Promax Suspended Ø30.9
Griffe	Urban Gist
Pedale	Aluminium
Vordere lampe	Busch Muller
Rücklicht	Trelock
Vorhängeschloss	Abus
Bemerkung	(*)

79



@fanticbikes



Fantic Bikes



Fantic Bikes



Fantic Motor



@fanticmotor_official

fantic.com

FANTIC

Fantic:
**Wir entwerfen,
entwickeln
und montieren
leistungsstarke
Elektrofahrräder.**

Fantic Motor S.P.A.
Via Tarantelli, 7
31030 Dosson di Casier (TV) **Italy**
info@fanticmotor.it
fantic.com